



# SLC 500 EtherNet/IP Adapter

Catalog Number 1747-AENTR



**Allen-Bradley**

by ROCKWELL AUTOMATION

User Manual

Original Instructions

## Important User Information

Read this document and the documents listed in the additional resources section about installation, configuration, and operation of this equipment before you install, configure, operate, or maintain this product. Users are required to familiarize themselves with installation and wiring instructions in addition to requirements of all applicable codes, laws, and standards.

Activities including installation, adjustments, putting into service, use, assembly, disassembly, and maintenance are required to be carried out by suitably trained personnel in accordance with applicable code of practice.

If this equipment is used in a manner not specified by the manufacturer, the protection provided by the equipment may be impaired.

In no event will Rockwell Automation, Inc. be responsible or liable for indirect or consequential damages resulting from the use or application of this equipment.

The examples and diagrams in this manual are included solely for illustrative purposes. Because of the many variables and requirements associated with any particular installation, Rockwell Automation, Inc. cannot assume responsibility or liability for actual use based on the examples and diagrams.

No patent liability is assumed by Rockwell Automation, Inc. with respect to use of information, circuits, equipment, or software described in this manual.

Reproduction of the contents of this manual, in whole or in part, without written permission of Rockwell Automation, Inc., is prohibited.

Throughout this manual, when necessary, we use notes to make you aware of safety considerations.



**WARNING:** Identifies information about practices or circumstances that can cause an explosion in a hazardous environment, which may lead to personal injury or death, property damage, or economic loss.



**ATTENTION:** Identifies information about practices or circumstances that can lead to personal injury or death, property damage, or economic loss. Attentions help you identify a hazard, avoid a hazard, and recognize the consequence.

**IMPORTANT** Identifies information that is critical for successful application and understanding of the product.

These labels may also be on or inside the equipment to provide specific precautions.



**SHOCK HAZARD:** Labels may be on or inside the equipment, for example, a drive or motor, to alert people that dangerous voltage may be present.



**BURN HAZARD:** Labels may be on or inside the equipment, for example, a drive or motor, to alert people that surfaces may reach dangerous temperatures.



**ARC FLASH HAZARD:** Labels may be on or inside the equipment, for example, a motor control center, to alert people to potential Arc Flash. Arc Flash will cause severe injury or death. Wear proper Personal Protective Equipment (PPE). Follow ALL Regulatory requirements for safe work practices and for Personal Protective Equipment (PPE).

The following icon may appear in the text of this document.



Identifies information that is useful and can help to make a process easier to do or easier to understand.

	<b>Preface</b>	
	About This Publication .....	7
	Download Firmware, AOP, EDS, and Other Files .....	7
	Summary of Changes.....	7
	Additional Resources .....	7
	<b>Chapter 1</b>	
<b>About the SLC 500 EtherNet/IP Adapter</b>	Overview.....	9
	Module Description .....	9
	Hardware Components.....	10
	The 1747-AENTR in a Logix System .....	11
	Hardware/Software Compatibility.....	11
	Diagnostic Indicators .....	11
	What the Adapter Does .....	11
	Use of the Common Industrial Protocol (CIP).....	12
	Understand the Producer/Consumer Model .....	12
	Support of Direct Connections .....	12
	Chapter Summary .....	13
	<b>Chapter 2</b>	
<b>Install Your Adapter</b>	Set the Network Address Switches .....	15
	Enable or Disable the Web Server .....	16
	Determine Power Requirements.....	18
	Install the Adapter Module in the Chassis .....	18
	Connect Your Adapter to the Ethernet/IP Network through RJ-45 Connection.....	19
	Chapter Summary .....	20
	<b>Chapter 3</b>	
<b>Configure the Adapter for Your EtherNet/IP Network</b>	Configuration Requirements.....	21
	IP Address .....	21
	Gateway Address .....	22
	Subnet Mask .....	23
	Use the Rockwell Automation BootP/DHCP Utility .....	24
	Save the Relation List .....	25
	Use DHCP Software to Configure Your Adapter.....	26
	Chapter Summary .....	26

<b>Plan to Use Your EtherNet/IP Adapter</b>	<p><b>Chapter 4</b></p> <p>Compatible 1746 and 1747 I/O Modules . . . . . 27</p> <p>Overview of Adapter Operation . . . . . 29</p> <p>    Software Requirements . . . . . 29</p> <p>    Module Connections . . . . . 29</p> <p>    Module Keying . . . . . 30</p> <p>    Output Operation During Fault and Idle Modes . . . . . 30</p> <p>Chapter Summary . . . . . 31</p>
<b>Configure the Adapter for Direct Connection through the RSLogix 5000 or Logix Designer Application</b>	<p><b>Chapter 5</b></p> <p>Overview . . . . . 33</p> <p>Set Up the Hardware . . . . . 33</p> <p>Create the Example Application . . . . . 34</p> <p>Configure the I/O . . . . . 35</p> <p>    Add the Local EtherNet/IP Bridge to the I/O Configuration . . . . . 35</p> <p>Add the Adapter to the I/O Configuration . . . . . 37</p> <p>    Add I/O Modules to the I/O Configuration . . . . . 39</p> <p>    Add Specialty I/O Modules using Advanced Connection . . . . . 42</p> <p>Download the Program to the Controller . . . . . 46</p> <p>Custom Settings (Edit Adapter Configuration) . . . . . 47</p> <p>Custom Settings for your I/O Module . . . . . 50</p> <p>Online Monitoring . . . . . 53</p> <p>Chapter Summary . . . . . 53</p>
<b>Troubleshoot with the Status Indicators</b>	<p><b>Chapter 6</b></p> <p>Interpret the Indicators . . . . . 55</p> <p>Chapter Summary . . . . . 57</p>
<b>Specifications</b>	<p><b>Appendix A</b></p> <p>. . . . . 59</p>
<b>Adapter Web Dialogs</b>	<p><b>Appendix B</b></p> <p>Overview . . . . . 61</p> <p>Work with the Home Page . . . . . 61</p> <p>Work with the Diagnostics Pages . . . . . 62</p> <p>    Use the Diagnostic Overview Page . . . . . 63</p> <p>    Use the Network Settings Page . . . . . 65</p> <p>    Use the Ethernet Statistics Page . . . . . 66</p> <p>    Use the I/O Connections Page . . . . . 67</p> <p>Work with the Configuration Pages . . . . . 68</p> <p>    Use the Device Identity Page . . . . . 69</p> <p>    Use the Network Configuration Page . . . . . 69</p> <p>    Use the Device Services Page . . . . . 71</p>

---

<b>Configure the RSLinx Ethernet Communication Driver</b>	<b>Appendix C</b>	
	Overview .....	73
	Install the RSLinx Software .....	73
	Configure the AB_ETH/IP Driver .....	73
	<b>Index</b>	
	.....	77

**Notes:**

## About This Publication

Describes the procedures you use to install, program and troubleshoot your EtherNet/IP™ Adapter module. This manual also includes several application examples.

## Download Firmware, AOP, EDS, and Other Files

Download firmware, associated files (such as AOP, EDS, and DTM), and access product release notes from the Product Compatibility and Download Center at [rok.auto/pcdc](http://rok.auto/pcdc).

## Summary of Changes

This publication contains the following new or updated information. This list includes substantive updates only and is not intended to reflect all changes.

Topic	Page
Updated template	throughout
Added section Enable or Disable the Web Server	16..18

## Additional Resources

These documents contain additional information concerning related products from Rockwell Automation.

Resource	Description
Ethernet Design Considerations Reference Manual, <a href="#">ENET-RM002</a>	Provides design considerations such as EtherNet/IP infrastructure components, features, protocol and prediction of system performance.
EtherNet/IP Device Level Ring Application Technique, publication <a href="#">ENET-AT007</a>	Describes DLR network operation, topologies, configuration considerations, and diagnostic methods.
EtherNet/IP Web Server Module User Manual, <a href="#">ENET-UM527</a>	Describes how to use the EtherNet/IP Web server module.
EtherNet/IP Network Devices User Manual, <a href="#">ENET-UM006</a>	Describes how to use EtherNet/IP communication modules in Logix 5000™ control systems.
Ethernet Reference Manual, <a href="#">ENET-RM002</a>	Describes basic Ethernet concepts, infrastructure components, and infrastructure features.
System Security Design Guidelines Reference Manual, <a href="#">SECURE-RM001</a>	Provides guidance on how to conduct security assessments, implement Rockwell Automation products in a secure system, harden the control system, manage user access, and dispose of equipment.
UL Standards Listing for Industrial Control Products, publication <a href="#">CMPNTS-SR002</a>	Assists original equipment manufacturers (OEMs) with construction of panels, to help ensure that they conform to the requirements of Underwriters Laboratories.
American Standards, Configurations, and Ratings: Introduction to Motor Circuit Design, publication <a href="#">IC-AT001</a>	Provides an overview of American motor circuit design based on methods that are outlined in the NEC.
Industrial Components Preventive Maintenance, Enclosures, and Contact Ratings Specifications, publication <a href="#">IC-TD002</a>	Provides a quick reference tool for Allen-Bradley industrial automation controls and assemblies.
Safety Guidelines for the Application, Installation, and Maintenance of Solid-state Control, publication <a href="#">SGI-1.1</a>	Designed to harmonize with NEMA Standards Publication No. ICS 1.1-1987 and provides general guidelines for the application, installation, and maintenance of solid-state control in the form of individual devices or packaged assemblies incorporating solid-state components.
Industrial Automation Wiring and Grounding Guidelines, publication <a href="#">1770-4.1</a>	Provides general guidelines for installing a Rockwell Automation industrial system.
Product Certifications website, <a href="http://rok.auto/certifications">rok.auto/certifications</a> .	Provides declarations of conformity, certificates, and other certification details.

You can view or download publications at [rok.auto/literature](http://rok.auto/literature).

---

**Notes:**



## About the SLC 500 EtherNet/IP Adapter

### Overview

This chapter provides an introduction to the features and functionalities of the 1747-AENTR SLC™ 500 EtherNet/IP Adapter. It includes the following sections.

Topic	Page
Module Description	9
Hardware Components	10
The 1747-AENTR in a Logix System	11
Hardware/Software Compatibility	11
Diagnostic Indicators	11
What the Adapter Does	11
Use of the Common Industrial Protocol (CIP)	12
Understand the Producer/Consumer Model	12
Support of Direct Connections	12

### Module Description

The 1747-AENTR Adapter enables CompactLogix™ and ControlLogix® processors to control SLC™ I/O modules. It is primarily designed to enable migration of existing SLC controlled systems to Logix-based systems.

The adapter mainly acts as a gateway between the SLC backplane and EtherNet/IP and typically replaces an SLC controller in the 1746 rack. On remote SLC racks, it replaces the 1747-ASB module or the ControlNet® adapters 1747-ACN15 and 1747-ACNR15.

Control of the backplane I/O is accomplished with a CompactLogix or ControlLogix controller communicating through an EtherNet/IP router in the Logix backplane, across EtherNet/IP, and into the 1747-AENTR gateway.

As a gateway between the SLC backplane and EtherNet/IP, the 1747-AENTR module is a CIP™ server (for both Explicit Messaging and I/O) on the Ethernet port, and an SLC host on the 1746 backplane.

Connections can be made to support 1746 and 1747 analog, digital, and specialty I/O modules installed in the backplane.

- 
- IMPORTANT** Studio 5000 Logix Designer® application (previously RSLogix 5000®) revision 21 and later, and firmware revision 2.001 and later supports:
- multiple chassis, with a maximum number of three chassis;
  - a maximum of 30 SLC I/O modules;
  - a maximum of 96 Class 1 connections;
  - up to 8 Class 3 connections.
- 

For the complete list of supported I/O modules, see the table, [List of I/O Modules Supported by the 1747-AENTR Adapter on page 27](#).

# Hardware Components

The adapter module consists of the following hardware components:

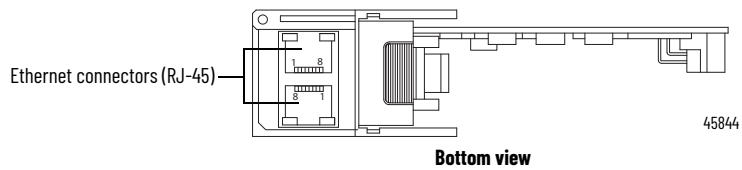
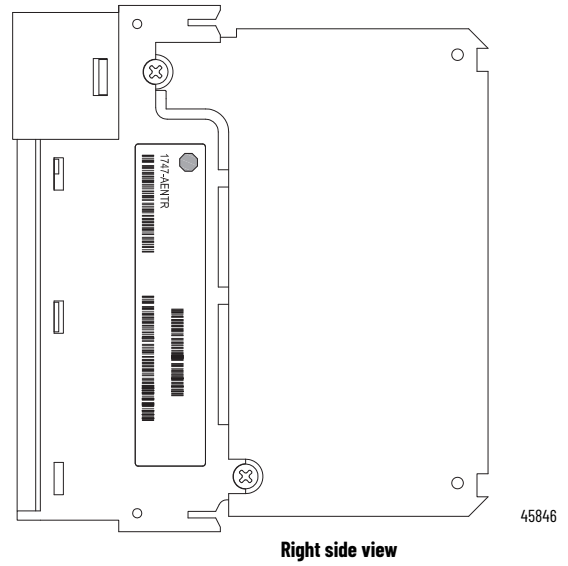
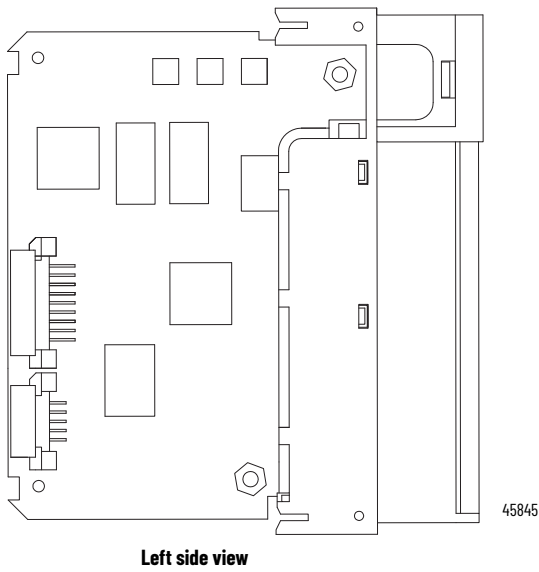
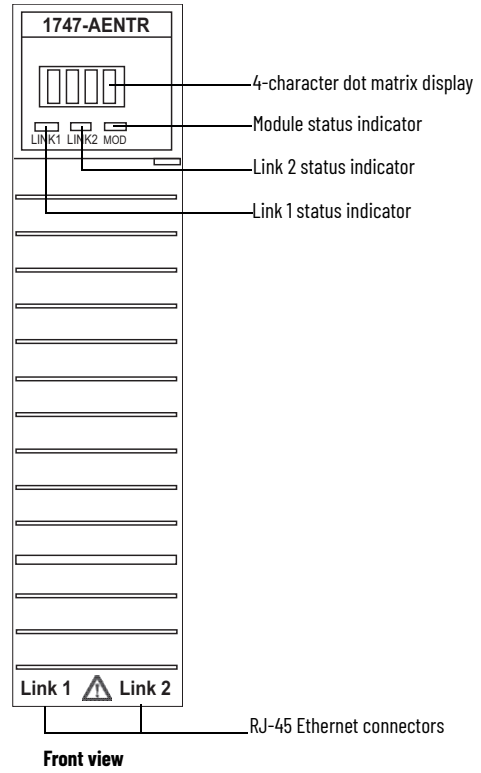
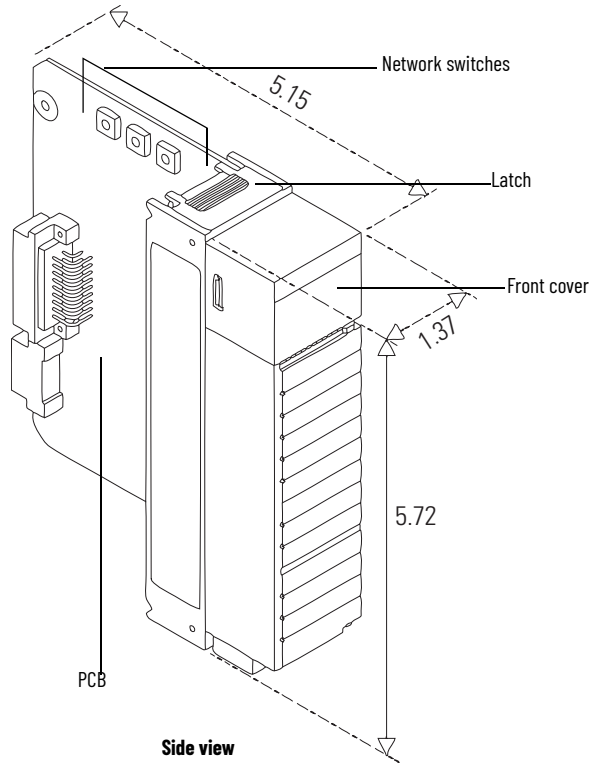

## The 1747-AENTR in a Logix System

In this example, the I/O modules communicate with the controller through the 1747-AENTR adapter. The controller can produce and consume tags to the I/O. Configuration of devices and the network is done through the personal computer running the controller and configuration software.

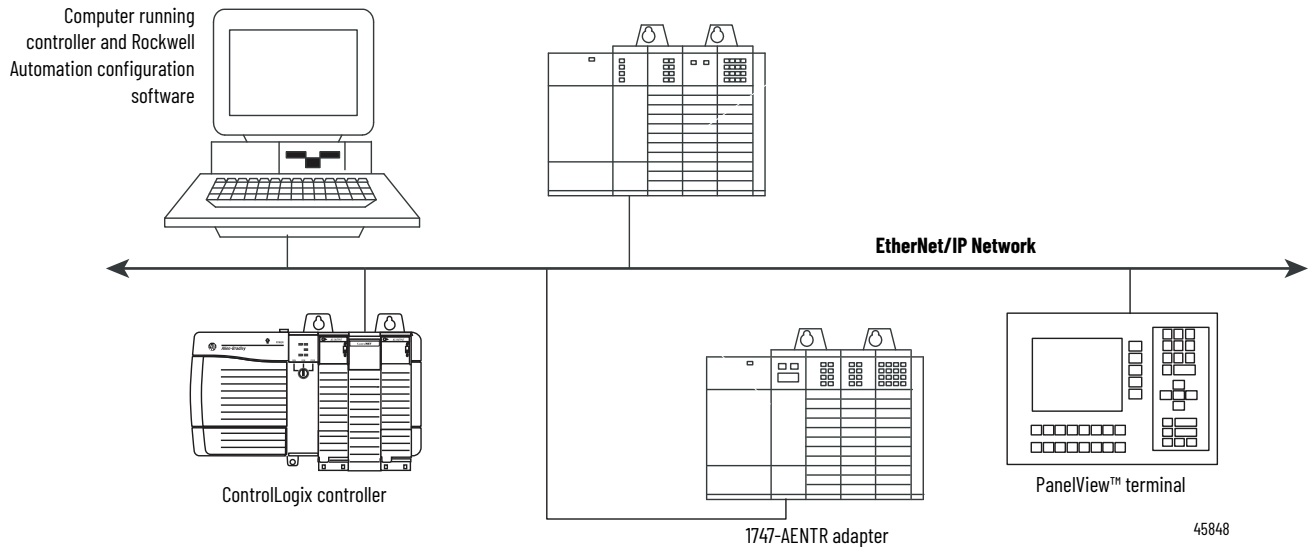

## Hardware/Software Compatibility

The adapter and the applications described in this manual is compatible with the following firmware revisions and software releases.

Product	Firmware Revision/ Software Versions
1747-AENTR	1.001 or later
Logix controller	v20 or later
RSLogix 5000 or Logix Designer	v20 or later
RSLinx® software	v2.59 or later

## Diagnostic Indicators

The module has the following diagnostic indicators:

- Link 1 and Link 2 status indicator
- Module indicator
- 4-character status display

## What the Adapter Does

The 1747-AENTR EtherNet/IP adapter performs the following primary tasks:

- Control of real-time I/O data (also known as implicit messaging) – the adapter serves as a bridge between I/O modules and the network
- Support of messaging data for configuration and programming information (also known as explicit messaging)

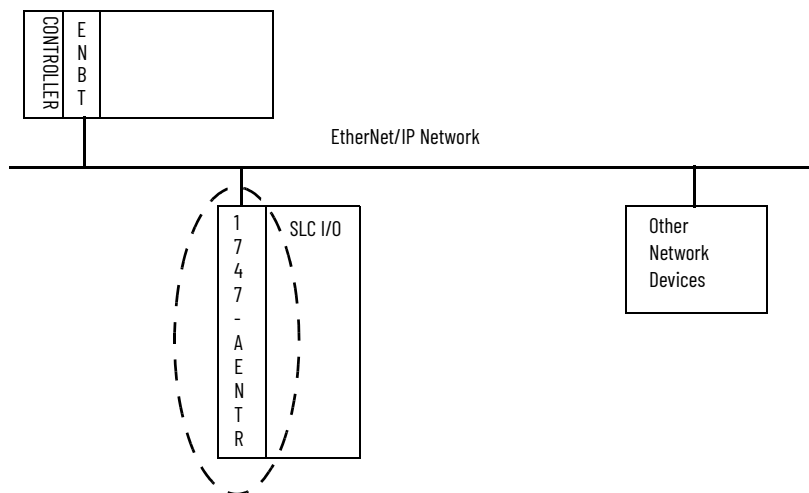

## Use of the Common Industrial Protocol (CIP)

The adapter uses the Common Industrial Protocol (CIP), the application layer protocol specified for EtherNet/IP, the Ethernet Industrial Protocol. It is a message-based protocol that implements a relative path to send a message from the producing device in a system to the consuming devices.

The producing device contains the path information that steers the message along the proper route to reach its consumers. Since the producing device holds this information, other devices along the path simply pass this information; they do not store it.

This has the following significant benefits:

- You do not need to configure routing tables in the bridging modules, which greatly simplifies maintenance and module replacement.
- You maintain full control over the route taken by each message, which enables you to select alternative paths for the same end device.

## Understand the Producer/Consumer Model

The CIP producer and consumer networking model replaces the old source and destination (master and slave) model. The producer and consumer model reduces network traffic and increases speed of transmission. In traditional I/O systems, controllers poll input modules to obtain their input status. In the CIP system, input modules are not polled by a controller. Instead, they produce (multicast or unicast) their data periodically or at a cyclic rate.

Unicast is the default for version 20 with multicast as a selectable option. The frequency of update depends upon the options chosen during configuration and where on the network the input module resides. The input module, therefore, is a producer of input data, and the controller is a consumer of the data.

The controller also produces data for other controllers to consume. The produced and consumed data is accessible by multiple controllers and other devices over the EtherNet/IP network. This data exchange conforms to the producer and consumer model.

## Support of Direct Connections

The EtherNet/IP adapter only supports direct connections. A direct connection is a real-time data transfer link between a Logix controller and a 1746/1747 I/O module through the 1747-AENTR adapter. Direct I/O connections occur at a cyclic rate specified by the RPI during configuration.

The adapter can support direct connections to devices in expansion racks. This feature is supported on Logix Designer application (previously RSLogix 5000 software) revision 21 and later, and firmware revision 2.001 and later.

See the EtherNet/IP Network Devices User Manual, publication [ENET-UM006](#), for more information on connections.

## Chapter Summary

This chapter provided an overview of the module features, what it does, and its function in a Logix system.

**Notes:**

## Install Your Adapter

This chapter describes how to install the 1747-AENTR adapter and connect it to the EtherNet/IP network.

The following table lists where to find specific information.

Topic	Page
Set the Network Address Switches	15
Determine Power Requirements	18
Install the Adapter Module in the Chassis	18
Connect Your Adapter to the Ethernet/IP Network through RJ-45 Connection	19
Chapter Summary	20

### Set the Network Address Switches

The network address switches are set to 999 and DHCP enabled, by default. You can set the network Internet Protocol (IP) address in the following ways:

- Use the network address switches on the module.
- Use a Dynamic Host Configuration Protocol (DHCP) server, such as Rockwell Automation BootP/DHCP.
- Retrieve the IP address from nonvolatile memory.

The adapter reads the network address switches first to determine if the switches are set to a valid number. You set the node address by using the network address switches. Valid settings range from 001...254.

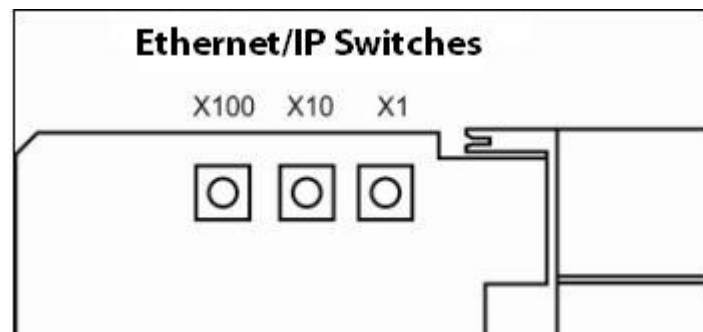

When the switches are set to a valid number, the adapter's IP address is 192.168.1.xxx (where xxx represents the number set on the switches).

The adapter's subnet mask is 255.255.255.0 and the gateway address is set to 0.0.0.0. The adapter does not have a host name assigned, or use any Domain Name System when using the network address switch settings.

If the switches are set to an invalid number (for example, 000 or a value greater than 254 excluding 888), the adapter checks to see if DHCP is enabled. Setting the switches to 888 restores default factory settings.

**IMPORTANT** If you set the value of the adapter switch to 888 and then power cycle the module, the following occurs:

- The DHCP Enabled function is enabled (set to True).
- The Ethernet link is negotiated automatically. The Auto Negotiate function is set to True.
- The web server is enabled. The Disabled Web Server function is disabled.
- The Ethernet ports are disabled. Both ports are re-enabled once the switches are returned to their previous value and power is cycled.

*DHCP Enabled and Not Enabled*

DHCP Enabled and Not Enabled	
If DHCP is	Then the Adapter
Enabled	Asks for an address from a DHCP server. The DHCP server also assigns other Transport Control Protocol (TCP) parameters. The 1747-AENTR factory default is DHCP enabled. When you apply power, the module sends a message containing its hardware address to any DHCP server on the network. The server(s) replies by sending a message with an appropriate IP address for the adapter. The adapter responds by acknowledging to a server that it will use the offered IP address.
Not enabled	Uses the IP address (along with other TCP configurable parameters) stored in nonvolatile memory. When the IP address assigned to the module, as indicated in the four-character dot-matrix status display, is changed through the DHCP configuration utility, the DHCP is disabled. When power is cycled to the device, it uses the new configuration and implements the new IP address.

See the chapter, [Configure the Adapter for Your EtherNet/IP Network on page 21](#), for information on how to use your BootP/DHCP utility to configure your adapter for the network.

**Enable or Disable the Web Server**

With firmware revision 2.003 or later, the web server feature is disabled by default. Use the network address switches to enable or disable the web server for your application.

Value	Description
000	Enables the web server. Cycle power to the adapter for the setting to take effect. When you apply power, the module LED flashes red and the four-character status display scrolls the message "Web Server Enabled".
901	Disables the web server. Cycle power to the adapter for the setting to take effect. When you apply power, the module LED flashes red and the four-character status display scrolls the message "Web Server Disabled".

**IMPORTANT** If you set the value of the switch to 901 and then cycle power to the adapter, the following occurs:

- The web server is disabled.
- If the product supports SNMP, the SNMP server is also disabled.

This value is a transitional setting, the adapter does not operate while the switch remains at this value. After the message "Web Server Disabled" displays, change the value of the switch based on your IP address mode and cycle power to the adapter.

The following section describes how to enable or disable the web server based on the IP address mode that is used.



*Enable Web Server in Static IP mode*

1. Set the switches to 000 and cycle power to the adapter.  
The module LED flashes red and the four-character status display scrolls the message “Web Server Enabled”.
2. Set the switches to the desired IP address and cycle power to the adapter.
3. In your web browser, enter the IP address of the adapter.  
The web server home page displays.

*Disable Web Server in Static IP mode*

1. Set the switches to 901 and cycle power to the adapter.  
The module LED flashes red and the four-character status display scrolls the message “Web Server Disabled”.
2. Set the switches to the desired IP address and cycle power to the adapter.
3. In your web browser, enter the IP address of the adapter.  
The web server home page does not display.

*Enable Web Server in DHCP mode*

Before you begin, verify that you have an active DHCP server on your network.

1. Set the switches to 000 and cycle power to the adapter.  
The module LED flashes red and the four-character status display scrolls the message “Web Server Enabled”.
2. Set the switches to 999 and cycle power to the adapter.
3. In RSLinx software, check the IP address that was assigned to the adapter by the DHCP server and verify the connection.
4. In your web browser, enter the IP address of the adapter.  
The web server home page displays.

*Disable Web Server in DHCP mode*

Before you begin, verify that you have an active DHCP server on your network.

1. Set the switches to 901 and cycle power to the adapter.  
The module LED flashes red and the four-character status display scrolls the message “Web Server Disabled”.
2. Set the switches to 999 and cycle power to the adapter.
3. In RSLinx software, check the IP address that was assigned to the adapter by the DHCP server and verify the connection.
4. In your web browser, enter the IP address of the adapter.  
The web server home page does not display.

*Enable Web Server in User-set IP mode*

1. Set the switches to 000 and cycle power to the adapter.  
The module LED flashes red and the four-character status display scrolls the message “Web Server Enabled”.
2. Set the switches to 999 and cycle power to the adapter.
3. In RSLinx software, change the Port Configuration setting to “Manual IP”, set the desired IP address, and cycle power to the adapter.
4. In your web browser, enter the IP address of the adapter.  
The web server home page displays.

*Disable Web Server in User-set IP mode*

1. Set the switches to 901 and cycle power to the adapter.  
The module LED flashes red and the four-character status display scrolls the message “Web Server Disabled”.
2. Set the switches to 999 and cycle power to the adapter.
3. In RSLinx software, change the Port Configuration setting to “Manual IP”, set the desired IP address, and cycle power to the adapter.
4. In your web browser, enter the IP address of the adapter.  
The web server home page does not display.

## Determine Power Requirements

The Ethernet adapter requires 5V DC with current consumption of 470 mA. The power is supplied through backplane from SLC power supply. Remember to consider this requirement when planning your system configuration.

## Install the Adapter Module in the Chassis

After you set the appropriate switch assemblies for your adapter module, follow these procedures for installation.

See the Industrial Controller Wiring and Grounding Guidelines publication [1770-4.1](#) for proper grounding and wiring methods to use when installing your module.

1. Remove power from the I/O chassis before inserting (or removing) the module.
2. Align the circuit board with the chassis card guide in the left slot.

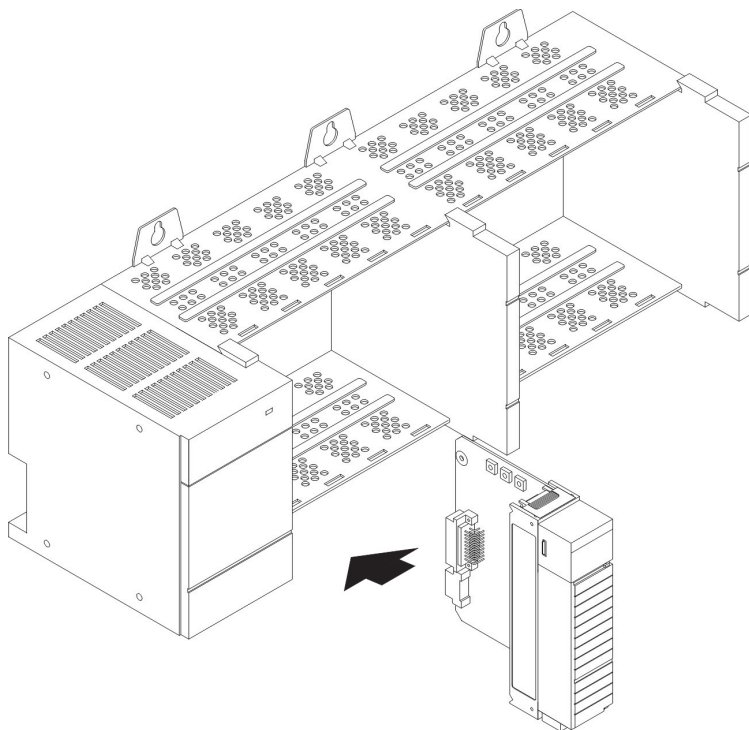

3. Install the module in slot 0 of the chassis by aligning the circuit board with the chassis card guide.  
The 1747-AENTR module must be installed only in slot 0 (leftmost slot) of the chassis.

- Press firmly and evenly to seat the module in its backplane connectors. To remove the module, press the releases at the top and bottom of the module and pull it out.



**ATTENTION:** Do not force the module into the backplane connector. If you cannot seat the module with firm pressure, check the alignment. Forcing the module can damage the backplane connector or the module.

## Connect Your Adapter to the Ethernet/IP Network through RJ-45 Connection

Connect your 1747-AENTR adapter module to an Ethernet/IP network as shown in the following example:

Wire the RJ-45 connectors as shown.

	Signal
1	TxData+
2	TxData-
3	Recv Data+
4	Reserved
5	Reserved
6	Recv Data-
7	Reserved
8	Reserved

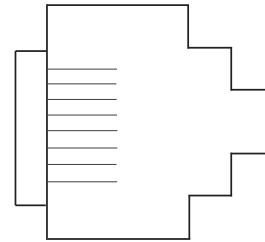

RJ-45

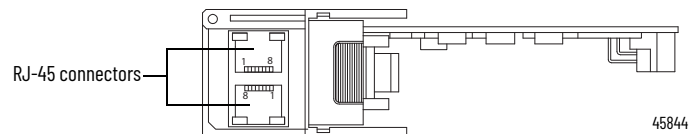

1747-AENTR module bottom view

To connect the module to the network, follow these steps:



**WARNING:** If you connect or disconnect the communication cable with power applied to this module or any device on the network, an electrical arc can occur. This could cause an explosion in hazardous location installations. Be sure that power is removed or the area is nonhazardous before proceeding.

- Attach the cables with the RJ-45 connectors to the two Ethernet ports on the bottom of the module.

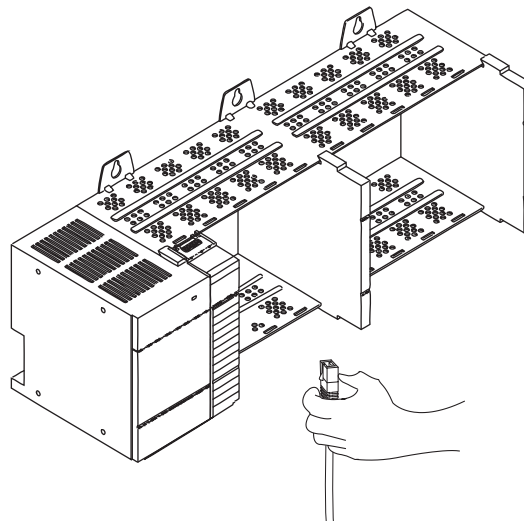

2. Attach the other end of the cables to the devices in your network.

---

**IMPORTANT** To install systems with rack extensions, you can see the SLC 500 Modular Hardware Style User Manual, publication [1747-UM01](#).

---

## Chapter Summary

This chapter provided instructions on how to install and wire the module. It also included power requirements for the module.

## Configure the Adapter for Your EtherNet/IP Network

Before using your adapter in an EtherNet/IP network, you need to configure it with an IP address, subnet mask, and optional Gateway address. This chapter describes these configuration requirements and the procedures for providing them. Here are ways you can do this:

- Use the Rockwell Automation BootP/DHCP utility, version 2.3 or later, that ships with RSLogix 5000 or RSLinx software.
  - You can also use this utility to reconfigure a device with an IP address you must change.
- Use a third party DHCP server.
- Use the Network Address rotary switches.
- Have your network administrator configure the adapter via the network DHCP server.

See the table for a list of where to find information in this chapter.

Topic	Page
Configuration Requirements	21
Use the Rockwell Automation BootP/DHCP Utility	24
Use DHCP Software to Configure Your Adapter	26

### Configuration Requirements

Before you can use your adapter, you must configure its IP address, its subnet mask, and, optionally, a gateway address. You can use the Rockwell Automation BootP utility, version 2.3 or later, to perform the configuration. You can also use a DHCP server or the network address switches to configure these parameters.

If you need to reset the adapter to factory defaults, see [Work with the Configuration Pages on page 68](#).

### IP Address

The IP address identifies each node on the IP network, or system of connected networks. Each TCP/IP node on a network, including the adapter, must have a unique IP address.

The IP address is 32 bits long and has a Network ID part and Host ID part. Networks are classified A, B, C, or other. The class of the network determines how an IP address is formatted.

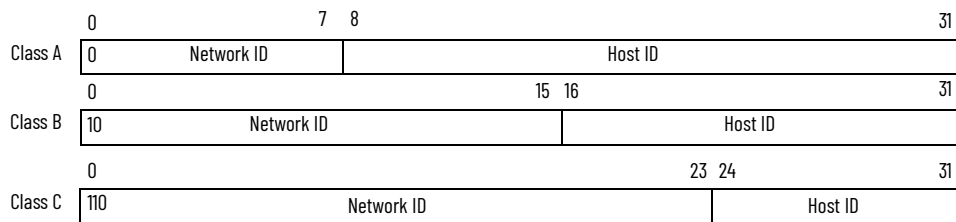

You can distinguish the class of the IP address from the first integer in its dotted-decimal IP address as follows:

Range of first integer	Class	Range of first integer	Class
0 1...27	A	192...223	C
128...191	B	224... 255	Other

Each node on the same physical network must have an IP address of the same class and must have the same network ID. Each node on the same network must have a different Host ID thus giving it a unique IP address.

IP addresses are written as four decimal integers (0...255) separated by periods where each integer gives the value of one byte of the IP address.

**EXAMPLE** For example, the 32-bit IP address:  
10000000 00000001 00000000 00000001 is written as 128.1.0.1

### Gateway Address

This section applies to multi-network systems. If you have a single network system, refer to the next section.

The Gateway Address is the default address of a network. It provides a single domain name and point of entry to the site. Gateways connect individual physical networks into a system of networks.

When a node needs to communicate with a node on another network, a gateway transfers the data between the two networks. The figure shows gateway G connecting Network 1 with Network 2.

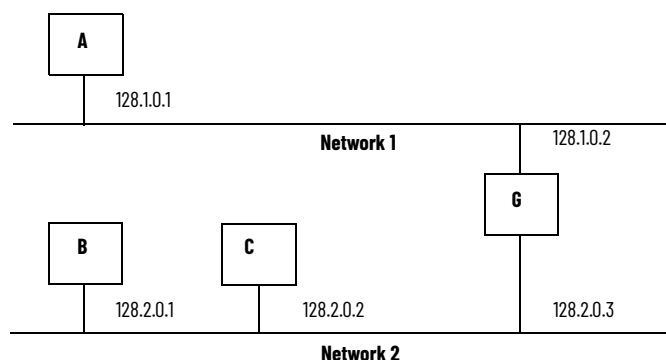

When host B with IP address 128.2.0.1 communicates with host C, it knows from C's IP address that C is on the same network. In an Ethernet environment, B can then resolve C's IP address into a hardware address (MAC address) and communicate with C directly.

When host B communicates with host A, it knows from A's IP address that A is on another network (the network IDs are different). In order to send data to A,

B must use the IP address of the gateway connecting the two networks. In this example, the gateway's IP address on Network 2 is 128.2.0.3.

The gateway has two IP addresses (128.1.0.2 and 128.2.0.3). The first must be used by hosts on Network 1 and the second must be used by hosts on Network 2. To be usable, a gateway of a host must be addressed using a network ID matching its own.

## Subnet Mask

The subnet mask is used for splitting IP networks into a series of subgroups, or subnets. The mask is a binary pattern that is matched up with the IP address to turn part of the Host ID address field into a field for subnets.

**EXAMPLE** Take Network 2 (a Class B network) in the previous example and add another physical network. Selecting the following subnet mask would add two additional network ID bits, allowing for four physical networks:

11111111 11111111 11000000 00000000 = 255.255.192.0

These two bits of the Host ID are used to extend the network ID.

Two bits of the Class B host ID are used to extend the network ID. Each unique combination of bits in the part of the Host ID where subnet mask bits are 1 specifies a different physical network.

The new configuration is:

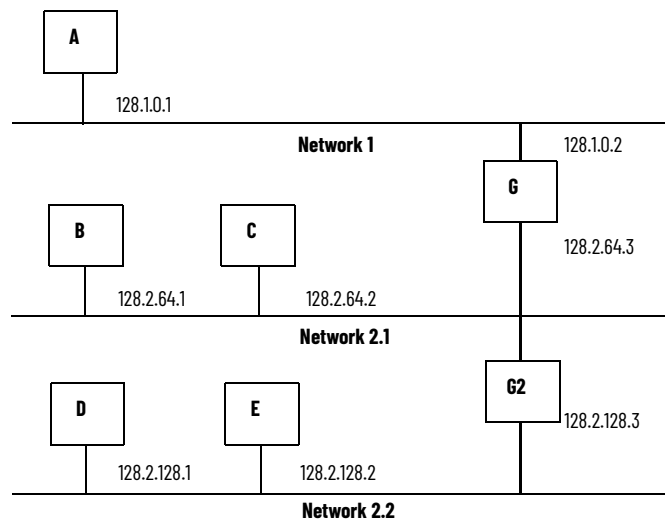

A second network with Hosts D and E was added. Gateway G2 connects Network 2.1 with Network 2.2.

Hosts D and E will use Gateway G2 to communicate with hosts not on Network 2.2.

Hosts B and C will use Gateway G to communicate with hosts not on Network 2.1.

When B is communicating with D, G (the configured Gateway for B) will route the data from B to D through G2.

## Use the Rockwell Automation BootP/DHCP Utility

The Rockwell Automation BootP/DHCP utility is a standalone program that incorporates the functionality of standard BootP software with a user friendly graphical interface. It is located in the Utility directory on the RSLogix 5000 software installation CD. The adapter must have DHCP enabled (factory default and the network address switches set to an invalid value) to use the utility.

To configure your adapter using the BootP utility, perform the following steps:

1. Run the BootP software.  
In the BOOTP Request History panel you see the hardware addresses of devices issuing BootP requests.

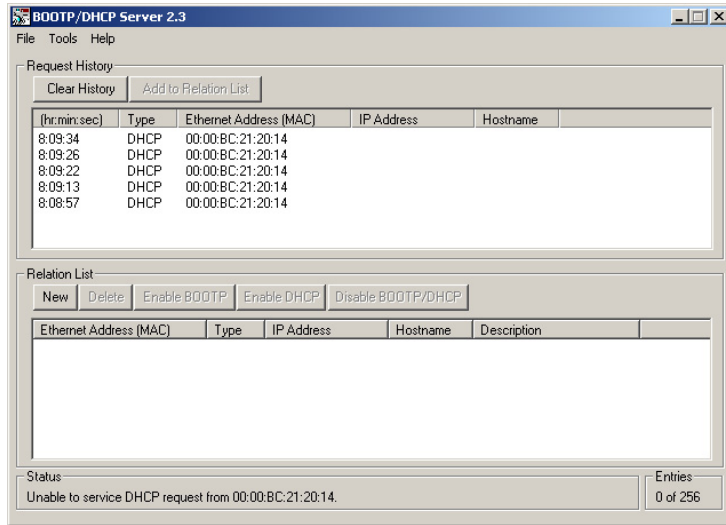

2. Double-click the hardware address of the device you want to configure. The New Entry dialog appears with the device's Ethernet Address (MAC).

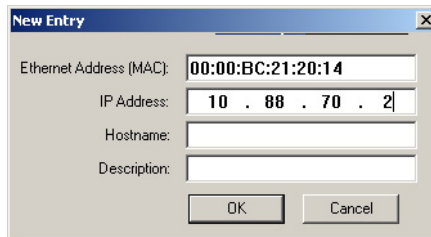

3. Enter the IP Address you want to assign to the device and click OK. The device is added to the Relation List, displaying the Ethernet Address



(MAC) and corresponding IP Address, Hostname, and Description (if applicable).

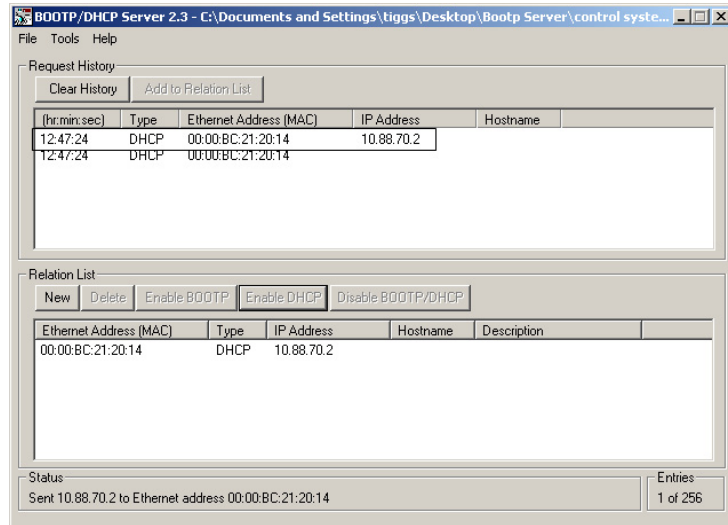

When the address displays in the IP Address column in the Request History section, the IP address assignment has been made.

4. To make this configuration static in the device, highlight the device in the Relation List panel, and click the Disable BOOTP/DHCP button. When power is cycled to the device, it uses the configuration saved in non-volatile memory and will not issue a DHCP request.
5. To enable DHCP for a device with DHCP disabled, highlight the device in the Relation List, and click the Enable DHCP button. You must have an entry for the device in the Relation List panel to re-enable DHCP.

## Save the Relation List

You can save the Relation List for later use. To save the Relation List, perform the following steps:

1. Select Save As... from the File menu.

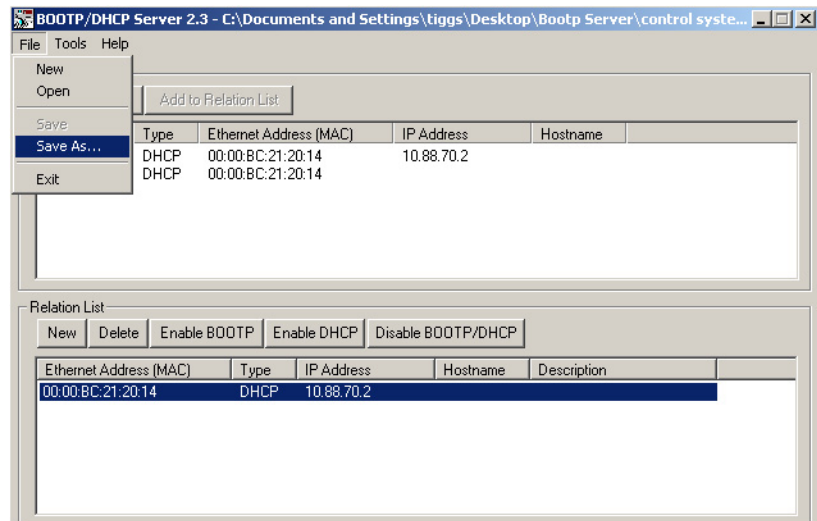

The Save As dialog appears.

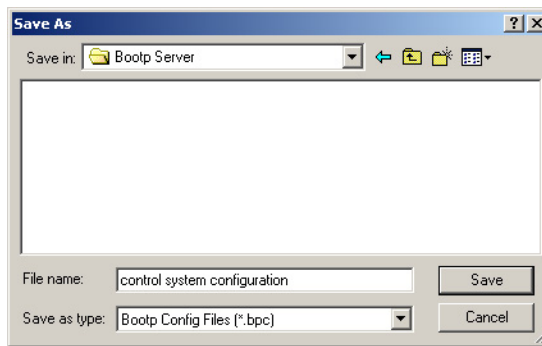

2. Select the folder where you want to save the Relation List.
3. Enter a File name for the Relation List, for example, control system configuration, and click Save.

You can leave the Save as type at the default setting: Bootp Config Files (\*.bpc).

You now have the option to open the file containing the Relation List at a later session.

## Use DHCP Software to Configure Your Adapter

DHCP (Dynamic Host Configuration Protocol) software automatically assigns IP addresses to client stations logging onto a TCP/IP network.

DHCP is based on BootP and maintains some backward compatibility. The main difference is that BootP was designed for manual configuration, while DHCP allows for dynamic allocation of network addresses and configurations to newly attached devices.

Be cautious about using DHCP software to configure your adapter. A DHCP server typically assigns a finite lease time to the offered IP address.

When 50% of the leased time has expired, the adapter attempts to renew its IP address with the DHCP server.

The possibility exists that the adapter will be assigned a different IP address, which would cause the adapter to cease communicating with the ControlLogix controller.

See Configure the Adapter with Fixed IP Address on page 45 to configure the adapter with a fixed IP address.



**ATTENTION:** To avoid unintended control or loss of control, the I/O adapter must be assigned a fixed IP address. A dynamically provided IP address should be used only at initial configuration. If a DHCP server is used, it must be configured to assign the same IP address to your adapter. Failure to observe this precaution may result in unintended machine motion or loss of process control.

## Chapter Summary

This chapter described the requirements and procedures for configuring the IP address, subnet mask, and optional Gateway address.

## Plan to Use Your EtherNet/IP Adapter

This chapter explains how the adapter operates on Ethernet and provides information to assist you in configuring your system. This includes information on:

- compatible 1746 and 1747 modules
- overview of adapter operation
- software requirements
- module connections
- module keying
- output operation during Fault and Idle modes

### Compatible 1746 and 1747 I/O Modules

The majority of 1746 and 1747 discrete, analog and specialty modules are compatible with the 1747-AENTR adapter.

The following tables provide lists of supported and unsupported modules.

**List of I/O Modules Supported by the 1747-AENTR Adapter**

Catalog Number	Type	Catalog Number	Type
1746-BAS	BASIC Module	1746-OBP8	DC Digital Output Module
1746-BAS-T	BASIC-T Module	1746-OG16	DC Digital Output Module
1746-IA4	AC Digital Input Module	1746-OV8	DC Digital Output Module
1746-IA8	AC Digital Input Module	1746-OV16	DC Digital Output Module
1746-IA16	AC Digital Input Module	1746-OV32	DC Output Module
1746-IB8	DC Digital Input Module	1746-OVP16	DC Digital Output Module
1746-IB16	DC Digital Input Module	1746-OW4	AC/DC Relay Output Module
1746-IB32	DC Input Module	1746-OW8	AC/DC Relay Output Module
1746-IC16	DC Digital Input Module	1746-OW16	AC/DC Relay Output Module
1746-IG16	DC Digital Input Module	1746-OX8	AC/DC Relay Output Module
1746-IH16	DC Digital Input Module	1746-FIO4I	Analog Combination Module
1746-IM4	AC Digital Input Module	1746-FIO4V	Analog Combination Module
1746-IM8	AC Digital Input Module	1746-INT4	Thermocouple Isolated Input Module
1746-IM16	AC Digital Input Module	1746-NI4	Analog Input Module
1746-IN16	AC/DC Digital Input Module	1746-NI8 <sup>(1)</sup>	Analog Input Module
1746-I04	Digital Combination Module	1746-NIO4I	Analog Combination Module
1746-I08	Digital Combination Module	1746-NIO4V	Analog Combination Module
1746-I012	Digital Combination Module	1746-NO4I	Analog Output Module
1746-I012DC	Digital Combination Module	1746-NO4V	Analog Output Module
1746-ITB16	DC Digital Input Module	1746-NR4	RTD/Resistance Input Module
1746-ITV16	DC Digital Input Module	1746-NT4	Thermocouple/mV Input Module
1746-IV8	DC Digital Input Module	1746-NI16V <sup>(1)</sup>	Analog Input Module
1746-IV16	DC Digital Input Module	1746-NI16I <sup>(1)</sup>	Analog Input Module
1746-IV32	DC Digital Input Module	1746-NR8 <sup>(1)</sup>	RTD/Resistance Input Module

## List of I/O Modules Supported by the 1747-AENTR Adapter (Continued)

Catalog Number	Type	Catalog Number	Type
1746-OA8	AC Digital Output Module	1746-NT8	Thermocouple/mV Input Module
1746-OA16	AC Digital Output Module	1746-N08 <sup>(1)</sup>	Analog Output Module
1746-OAP12	AC Digital Output Module	1746-N08V <sup>(1)</sup>	Analog Output Module
1746-OB6EI	DC Digital Output Module	1746-HSTP1	Stepper Controller Module
1746-OB8	DC Digital Output Module	1746-HSCE <sup>(2)</sup>	High-Speed Counter Module
1746-OB16	DC Digital Output Module	1746-HSCE2 <sup>(1)</sup>	Multi-Channel High-Speed Counter Module
1746-OB16E	DC Digital Output Module	1746-QS <sup>(2)</sup>	Synchronized Axes Control Module
1746-OB32	DC Digital Output Module	1746-OBP16	DC Digital Output Module
1746-OB32E	DC Digital Output Module		

(1) This module supports multiple operating classes. The 1747-AENTR adapter automatically promotes multiclass modules to the highest supported class. The 1746-NI16I, 1746-NI16V, 1746-NR8, 1746-NI8, 1746-N08I, 1746-N08V modules are promoted from class 1 to class 3. The 1746-HSCE2 module is promoted from class 1 to class 4.

(2) This specialty module uses Advanced module connection. Refer to the User Manual specific to the I/O module to learn about its connection configuration requirements.

## List of I/O Modules NOT Supported by the 1747-AENTR Adapter

Catalog Number	Type
1746-HSRV	Servo Control Module
1746-BTM <sup>(1)</sup>	Barrel Temperature Module
1747-DCM1 <sup>(1)</sup>	Direct Communication Modules
1747-DCM2 <sup>(1)</sup>	
1747-DCM3 <sup>(1)</sup>	
1747-DCM4 <sup>(1)</sup>	
1747-KE/A <sup>(1)</sup>	DH-485/RS-232C Interface Modules
1747-KE/B <sup>(1)</sup>	
1747-KFC15	ControlNet to RS-232C Interface Module
1747-SDN/D <sup>(1)</sup>	DeviceNet <sup>®</sup> Scanner module
1747-SCNR <sup>(1)</sup>	ControlNet Scanner module
1747-SN	Remote I/O Scanner Module
1747-BSN <sup>(2)</sup>	Back-Up Remote I/O Scanner Module
1746-QV	Open Loop Velocity Control Module
1746-BLM	Blow Molding Module
1746-MPM	Mold Pressure Module
1203-SM1 <sup>(1)</sup>	Scanport Module (Class 4 operation)

(1) The module is not supported by the 1747-AENTR but appears in the RSLogix 5000 pick list (Select Module Type dialog).

(2) The 1747-AENTR is not designed for redundancy support.

**IMPORTANT**

Any 1746/1747 module that is not included in the lists of supported and unsupported modules is **not** supported by the 1747-AENTR, as of the date of writing of this User Manual.

Consult the manufacturer of any third party module to determine if the module is supported by the 1747-AENTR adapter.

## Overview of Adapter Operation

As a gateway between the SLC backplane and EtherNet/IP, the 1747-AENTR module serves as a CIP server (for both Explicit Messaging and I/O) on the Ethernet port, and an SLC host on the 1746 backplane. Connections can be made to supported I/O modules installed in the backplane. See [List of I/O Modules Supported by the 1747-AENTR Adapter on page 27](#).

The module employs the Rockwell Automation Embedded Switch Toolkit. This implementation is an IEEE 802.3 standard compliant, Layer 2 switch that is compatible with the IEEE 802.1 ID standard. It has three ports: two are external ports that function as physical ports of the product and one is an internal port that connects to the host CPU. Each of the three ports has an IEEE 802.3 compliant MAC and the ports are interconnected with each other through full wire speed, non-blocking switching logic. The Embedded Switch Toolkit provides support for the EtherNet/IP DLR protocol.

The adapter only supports direct connection to individual modules. Up to 96 connections per adapter are possible with a maximum of 240 words supported per connection on firmware revision 2.001 and Logix Designer application revision 21. The input data attributes correspond directly to the read area of the I/O module's data table image. The output attributes correspond directly to the write area of the I/O module's data table image.

---

**IMPORTANT** On firmware revision 1.001 and RSLogix 5000 revision 20, the adapter only supports up to 32 connections per adapter, with a maximum of 240 words supported per connection.

---

Communication between the 1747-AENTR module and the I/O modules is polled, similar to an SLC controller scan cycle. The adapter maintains a list of the module ID for each slot, and handles electronic key validation during connection requests, while processing ForwardOpen requests to the Connection Manager.

## Software Requirements

RSLogix 5000 revision 20 or greater and RSLinx version 2.59 or greater are required to configure the 1747-AENTR adapter. For more information on how to configure your device, see [Configure the Adapter for Direct Connection through the RSLogix 5000 or Logix Designer Application on page 33](#).

---

**IMPORTANT** Logix Designer application (previously RSLogix 5000) revision 21 and later supports direct connections to more than 13 slots.

---

## Module Connections

The 1747-AENTR adapter supports module connections.

Module connection is performed in a deterministic and repeatable manner. This connection allows a memory and Ethernet bandwidth efficient way to connect to individual modules.

Each connection can be configured with the following connection types:

1. **Exclusive Owner** – specifies an independent connection where a single device controls the output states in the target device. If you have an existing Exclusive Owner connection to a target device, you cannot specify another Exclusive Owner or Redundant connection to that same target device.  
The 1747-AENTR adapter supports one Exclusive Owner connection per SLC module.

2. **Input Only** – specifies an independent connection where a device receives inputs from the target device and sends configuration data to the target device. An Input Only connection does not send outputs; it only receives inputs. You can specify multiple Input Only connections to the target device from different originators.  
The 1747-AENTR adapter supports up to five Input Only connections per SLC module.
3. **Listen Only** – specifies a dependent connection where a device receives inputs from the target device, but does not send configuration data with the target device. A Listen Only connection only functions properly when another non-Listen Only connection exists to the same target device. A Listen Only connection does not send outputs; it only receives inputs. You can specify multiple Listen Only connections to the target device from different originators.  
The 1747-AENTR adapter supports up to five Listen Only connections per SLC module.

---

**IMPORTANT** When a Listen Only connection is made, there must be an existing Exclusive Owner or Input Only connection, the connection RPIs must match exactly, the input chunk configuration (if any) must match exactly, and all connections to the same module must be Multicast.

Note that changing a module connection from Input Only to Listen Only will result to the following:

- reset the RPI to 20 ms
- reset the input chunk configuration (if any) to the default
- set the Input Type to Unicast

---



All Listen Only connections are terminated when all associated independent connections are terminated.

## Module Keying

Missing or misplaced modules are detected if the module in question is configured with RSLogix 5000 or Logix Designer application as an individual module connection and “compatible module” is selected for electronic keying. If a module connection is attempted to a module which is a missing or misplaced module, the connection will fail.

## Output Operation During Fault and Idle Modes

RSLogix 5000 or Logix Designer application allows configuration to characterize each module connection activity during certain operational states.

During idle mode and fault modes, outputs are configured for one of the following operation states:

Output Action
Reset outputs to off
Hold last state
Write Safe State data to outputs

For comprehensive information about Ethernet/IP networks, consult the following resources:

- Ethernet Reference Manual, publication [ENET-RM002](#)
- EtherNet/IP Network Devices User Manual, publication [ENET-UM006](#)

## Chapter Summary

This chapter provided an overview of adapter operation on an EtherNet/IP network that can assist you in configuring your system.

**Notes:**



## Configure the Adapter for Direct Connection through the RSLogix 5000 or Logix Designer Application

### Overview

In the following example, a ControlLogix controller communicates with I/O modules through the adapter using a direct connection.

The adapter makes a direct connection to each of the modules referenced by the data. The modules presented in this chapter use RSLogix 5000/Logix Designer application, revision 20 or later.

Topic	Page
Set Up the Hardware	33
Create the Example Application	34
Configure the I/O	35
Add the Local EtherNet/IP Bridge to the I/O Configuration	35
Add the Adapter to the I/O Configuration	37
Add I/O Modules to the I/O Configuration	39
Download the Program to the Controller	46
Custom Settings (Edit Adapter Configuration)	47
Custom Settings for your I/O Module	50

**IMPORTANT** The steps and screenshots used in this chapter refer to the RSLogix 5000 software, which has since been renamed to Logix Designer application. The configuration process in the Logix Designer application follows the same steps as the configuration process in RSLogix 5000.

**IMPORTANT** The 1747-AENTR device should always be installed in Slot 0. There should only be one 1747-AENTR device installed within the same rack or its connected rack extensions for multiple chassis support.

### Set Up the Hardware

In this example, a ControlLogix chassis contains the Logix5575 controller in slot 1 and a 1756-EN2TR bridge module in slot 3. The 1747-AENTR adapter is mounted on an SLC chassis in slot 0, with a 1746-IO8 input module in slot 1, a 1746-IA4 module in slot 2, a 1746-BAS/B module in slot 3, and a power supply.

To work along with this example, set up your system as shown in the figure.

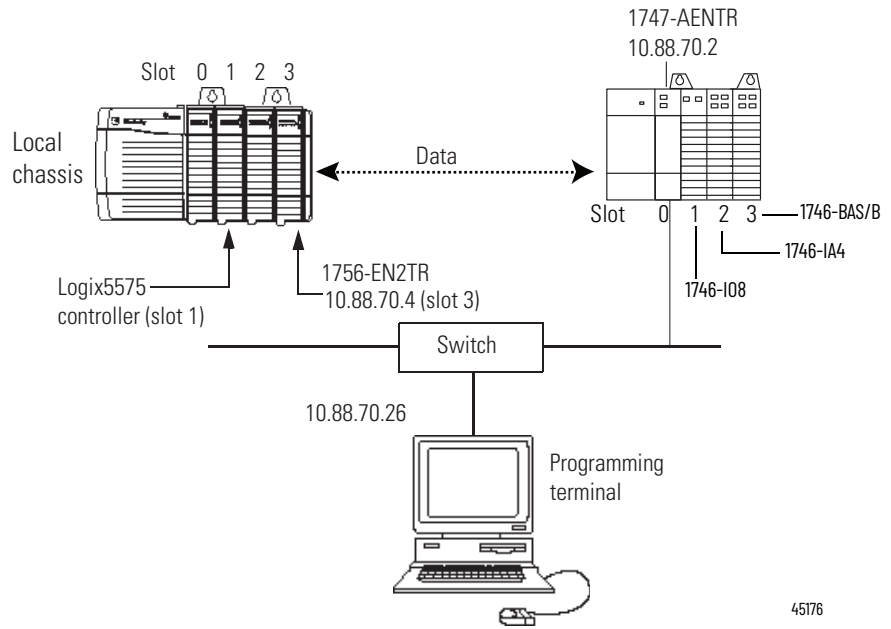

- In the example application, we assume that the Logix5575 controller and 1756-EN2TR module (firmware revision 3.1, or later) are in the slots shown in the figure.
- Verify the IP addresses for your programming terminal, 1756-EN2TR module, and adapter.
- Verify the position (slot) of the I/O modules on the DIN rail.
- Verify that you connected all wiring and cabling properly.
- Be sure you configured your communication driver (for example, AB\_ETH-1 or AB-ETHIP-1) in RSLinx software, as described in [Configure the AB ETH/IP Driver on page 73](#).

## Create the Example Application

Perform the following steps to create the example application:

1. Start RSLogix 5000 Enterprise Series software to open the RSLogix 5000 software main dialog.
2. From the File menu, select New.

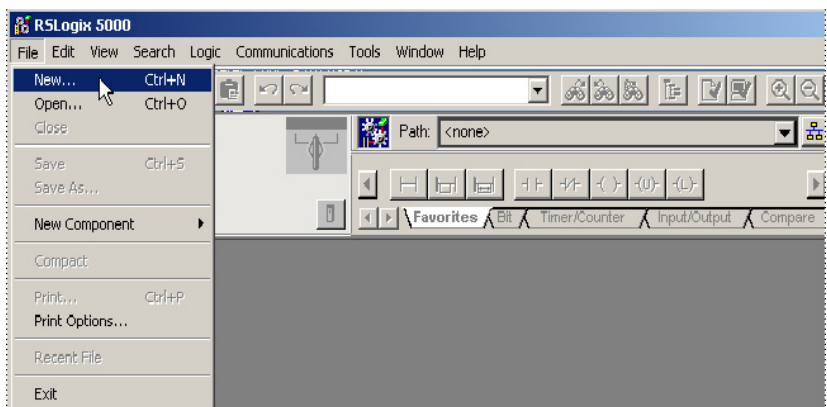

- The New Controller dialog opens.

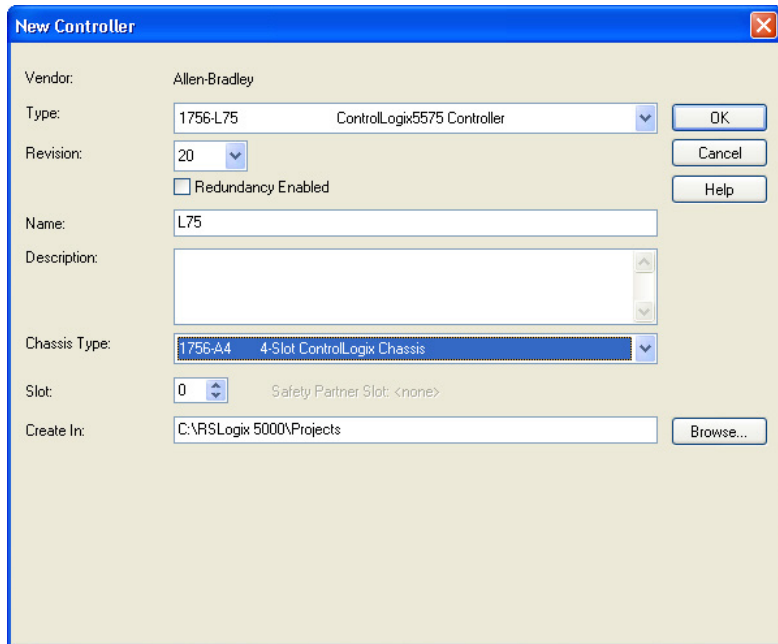

- Enter an appropriate Name for the Controller.
  - Select the correct Chassis Type, and Slot number of the Logix5575 controller, and the folder where you want to save the RSLogix 5000 file (Create In). The Description is optional.
- Click OK.

## Configure the I/O

Setting up a sample I/O Configuration project involves the following:

- Adding the local 1756-EN2TR module to the I/O configuration.
- Adding the 1747-AENTR adapter as a child of the 1756-EN2TR module on the Ethernet network.
- Adding I/O modules as children of the 1747-AENTR adapter.

---

**IMPORTANT** Click the Help button on the configuration dialogs shown in this section if you need assistance in selecting and setting the parameters.

---

### Add the Local EtherNet/IP Bridge to the I/O Configuration

- Right-click the I/O Configuration folder in the project dialog, and choose New Module from the dropdown list.

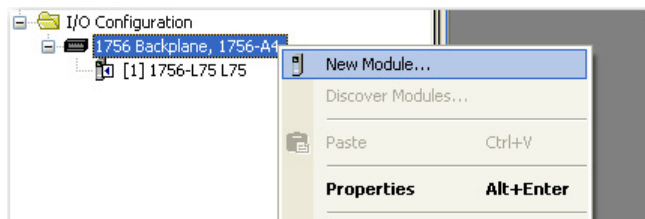

The Select Module Type dialog opens.

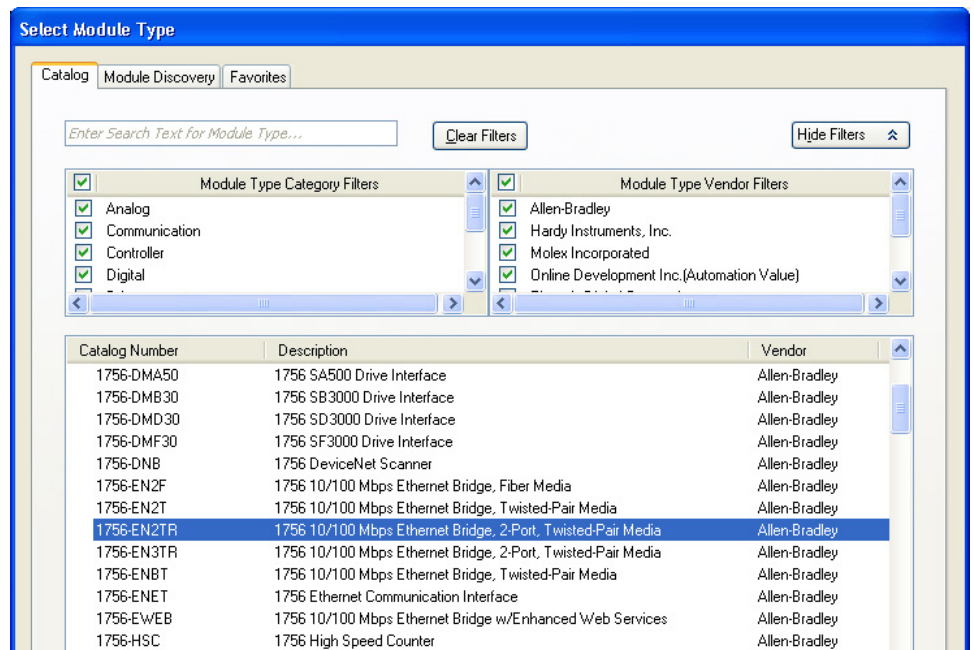

2. Select the 1756-EN2TR EtherNet/IP Bridge and click Create.
3. The New Module dialog opens. Configure your 1756-EN2TR EtherNet/IP Bridge module. You can configure the bridge module through the different tabs available.

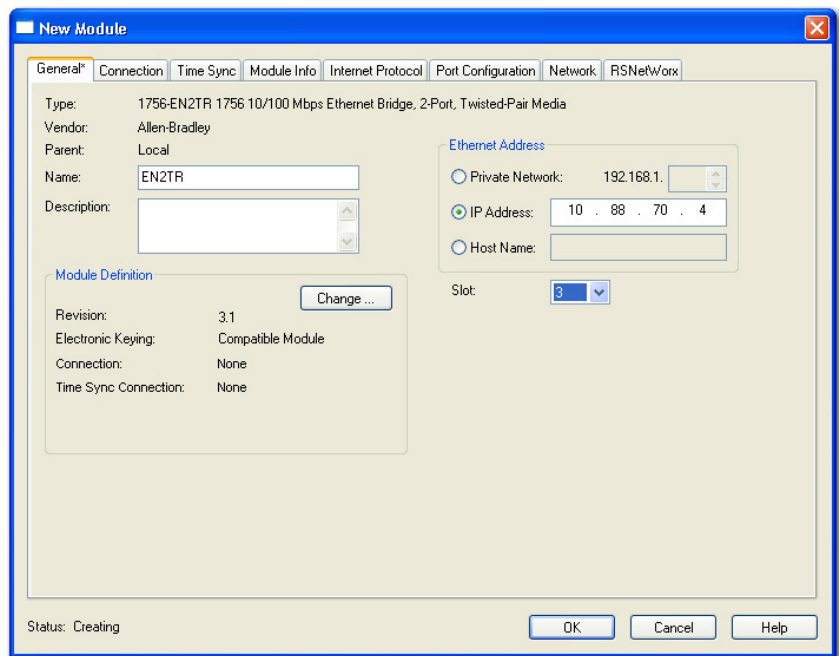

4. Enter values for Name, IP Address, Slot, Electronic Keying, and Revision, noting that we used the following values:

Name	EN2TR
IP Address	10.88.70.4
Slot	3
Electronic Keying	Compatible Module
Revision	3.1

5. Click OK to accept the configuration.

## Add the Adapter to the I/O Configuration

Next, you must add the 1747-AENTR adapter as a child of the local 1756-EN2TR module.

1. In the Project dialog, right-click the local 1756-EN2TR module under the I/O Configuration folder, and select New Module.

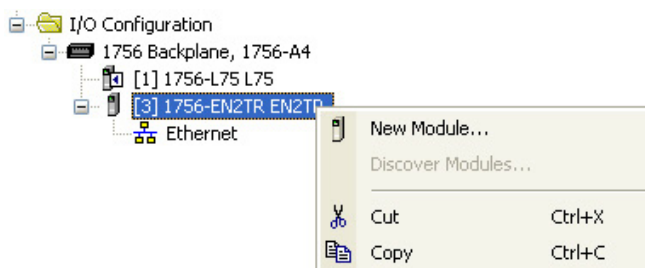

The Select Module Type dialog opens.

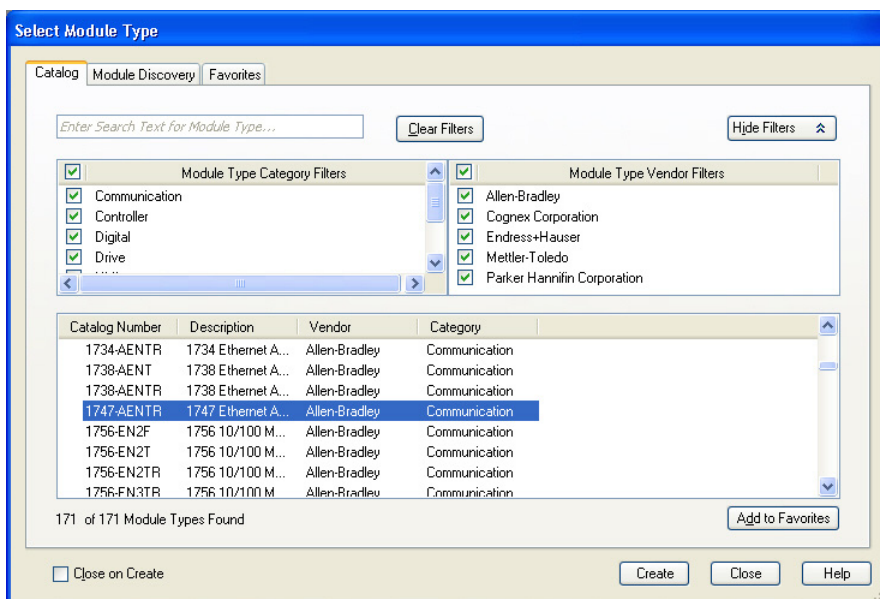

2. Choose 1747-AENTR. Click Create.

- The Module Properties dialog opens. Specify the properties of the adapter.

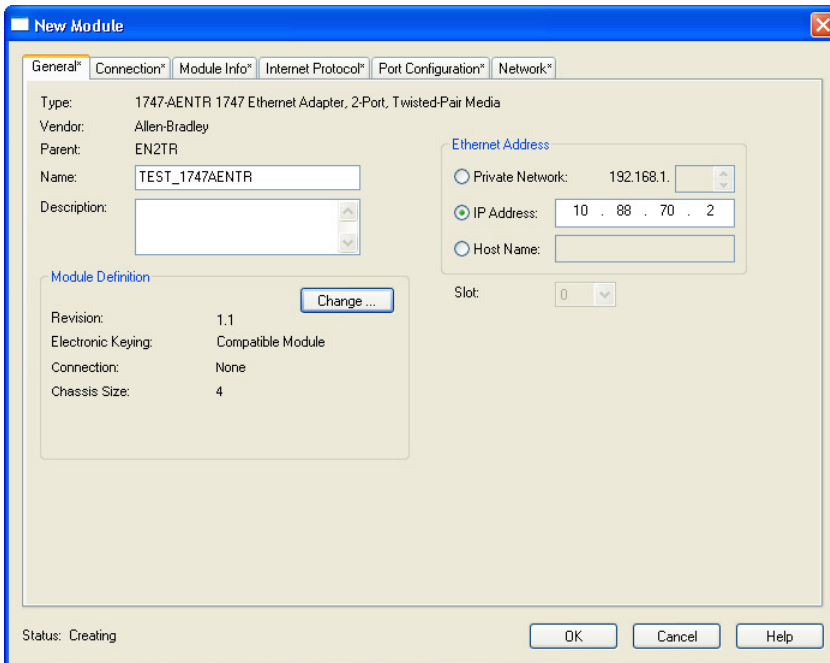

Note that for the purposes of illustration we have specified the following properties in the General tab of the New Module dialog.

Name	TEST_1747AENTR
IP Address	10.88.70.2
Slot	0

**IMPORTANT** The Slot field appears grey because the slot is automatically 0 for the 1747-AENTR adapter.

- Click Change... The Module Definition dialog opens.

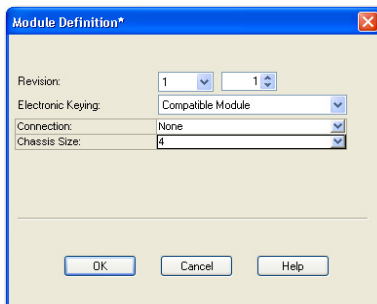

- Choose values for Chassis Size, Electronic Keying and Revision, noting that we used the following values for our example:

Connection	None (only choice available)
Chassis Size	4
Electronic Keying	Compatible Module
Revision	1.1

**IMPORTANT** The chassis size value equals 1 (for the adapter) plus the number of I/O modules installed or physically present on the I/O backplane.

Connection is None by default because we are only making direct connections.

- Click OK to accept the configuration.  
The name of your adapter appears under the Ethernet folder.

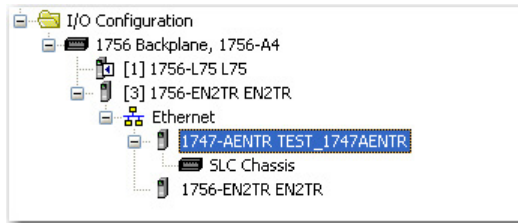

## Add I/O Modules to the I/O Configuration

First, check the [List of I/O Modules Supported by the 1747-AENTR Adapter on page 27](#), to see if your I/O module is supported by the adapter.

Then, add the I/O module to the I/O Configuration List under the adapter.

In this example, you add a 1746-IO8 and a 1746-IA4 module with standard configurations. Use these steps as a guide when configuring different I/O modules for your system.



This example application uses I/O module default configurations. For more information, refer to the SLC 500 Systems Selection Guide, publication [1747-SG001](#).

- Right-click the name of the 1747-AENTR adapter under the I/O Configuration folder and select New Module.

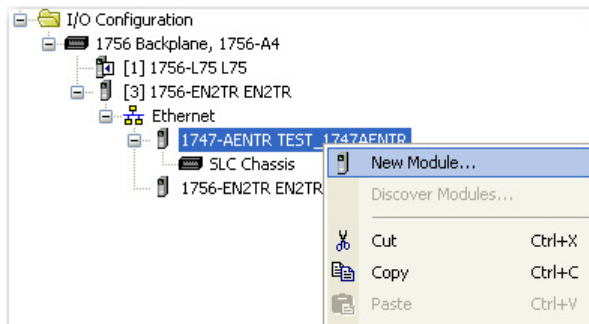

The Select Module Type dialog opens.

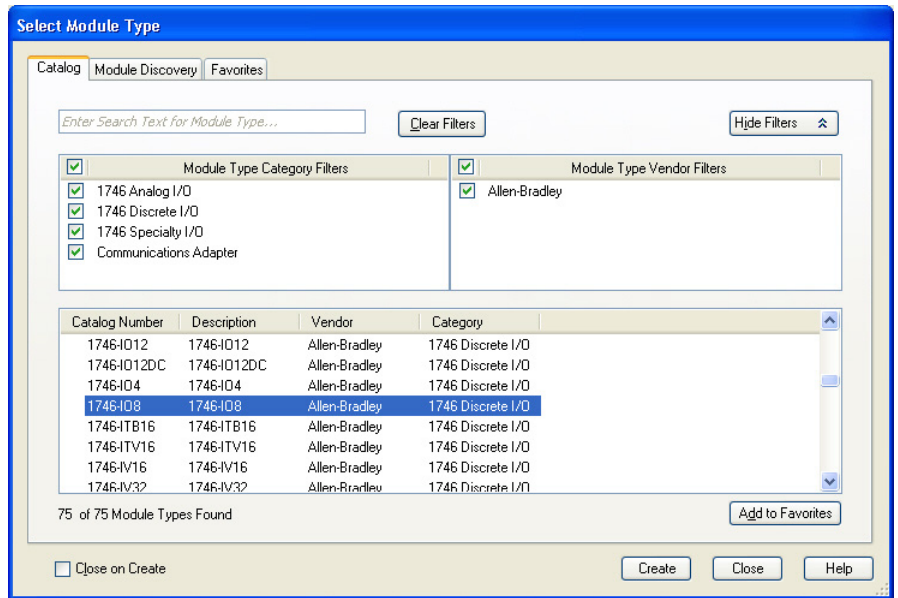

2. Select the 1746-IO8 module from the list and click Create.  
The New Module dialog opens.

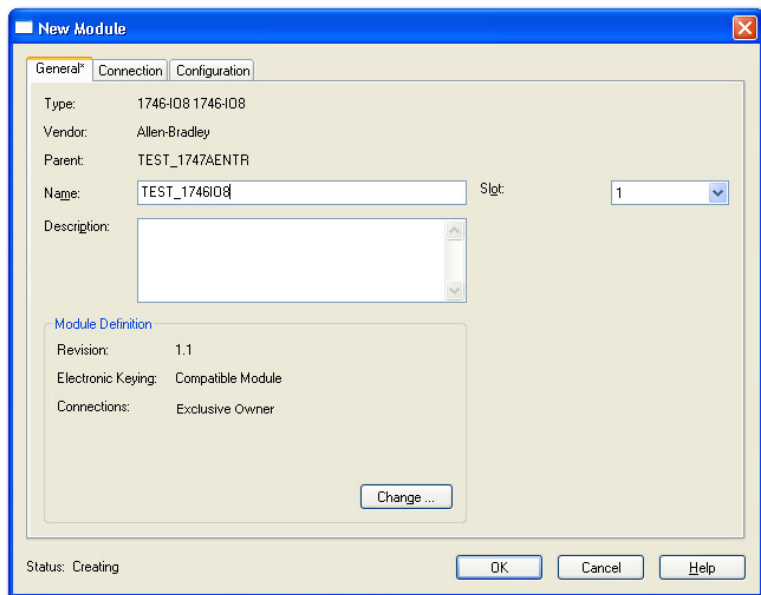

3. Enter values for Name and Slot, noting that we used the following values.

Name	TEST_1746IO8
Slot	1

4. Select the Connection tab.  
The RPI is selectable since it is a direct connection.



- Enter 50 for requested packet interval (RPI) to set how often you exchange data with the I/O adapter.

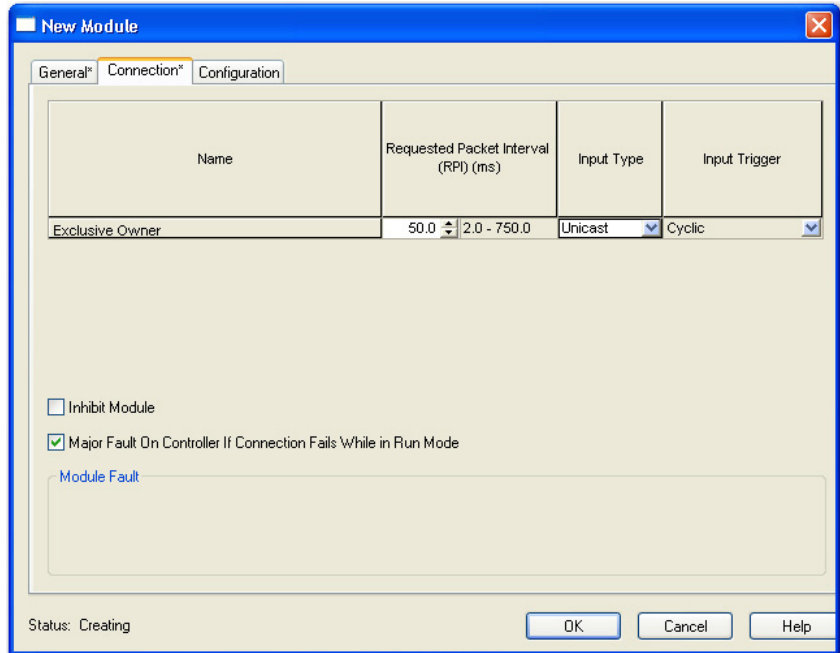

**IMPORTANT** The default RPI of 20 ms is suitable for typical applications.



Rockwell Automation recommends that you check or enable the option “Major Fault On Controller If Connection Fails While in Run Mode” on both the 1747-AENTR device and supported 1746 I/O modules.

- Click OK to save the configuration. The module now appears under the I/O Configuration tree.

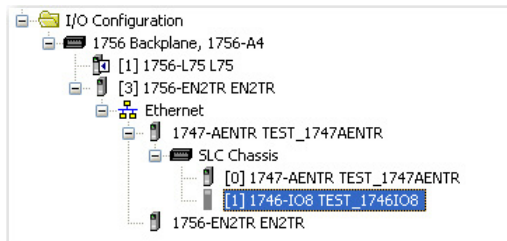

To add 1746-IA4 module to the project, follow the same procedure. After adding 1746-IA4, the I/O Configuration tree should appear as follows:

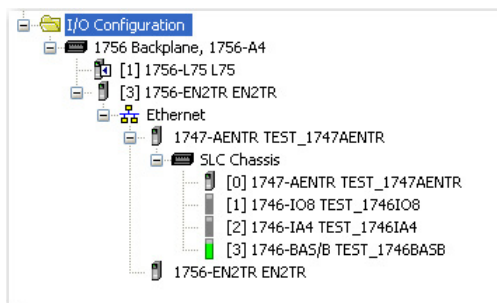

## Add Specialty I/O Modules using Advanced Connection

The previous example illustrates how to add I/O modules that use Simple connection. This section shows how to add and configure a specialty I/O module with Advanced connection (in this example, 1746-BAS/B).

**IMPORTANT** Consult the User Manual and related documentation for your I/O module to help you specify required values during configuration. User Manuals and other related publications for 1746/1747 modules are available in the Rockwell Automation Literature Library: [rok.auto/literature](http://rok.auto/literature). For the 1746-BAS/B module, for example, you can see the following publications to get module-specific configuration information:

- SLC 500 BASIC and BASIC-T Modules User Manual, publication [1746-UM004](#)
- BASIC Language Reference Manual, publication [1746-RM001](#)

Follow these steps to add and configure your 1746-BAS/B module.

1. In the I/O Configuration tree, right-click SLC Chassis or 1747-AENTR and choose New Module...

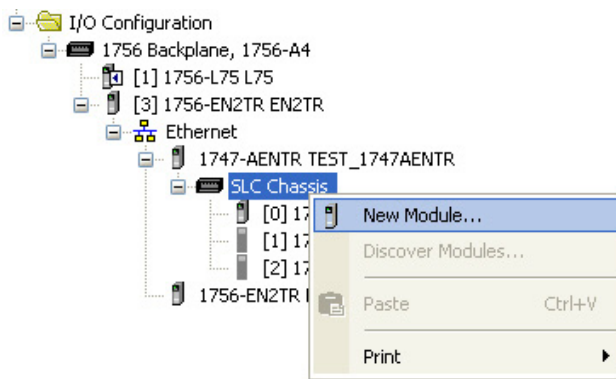

2. On the Select Module Type dialog that appears, select 1746-BAS/B and click Create.
3. Enter a name for the device.

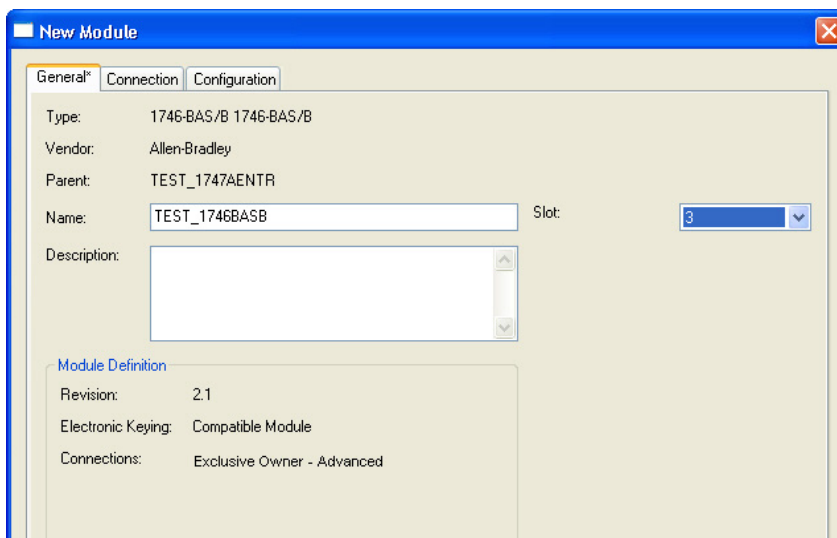

Note that the following values are used in this example.

Field	Value
Name	TEST_1746BASB
Revision	2.1
Electronic Keying	Compatible Module (default)
Connections	Exclusive Owner - Advanced (default)

- Click Change... on the General tab.

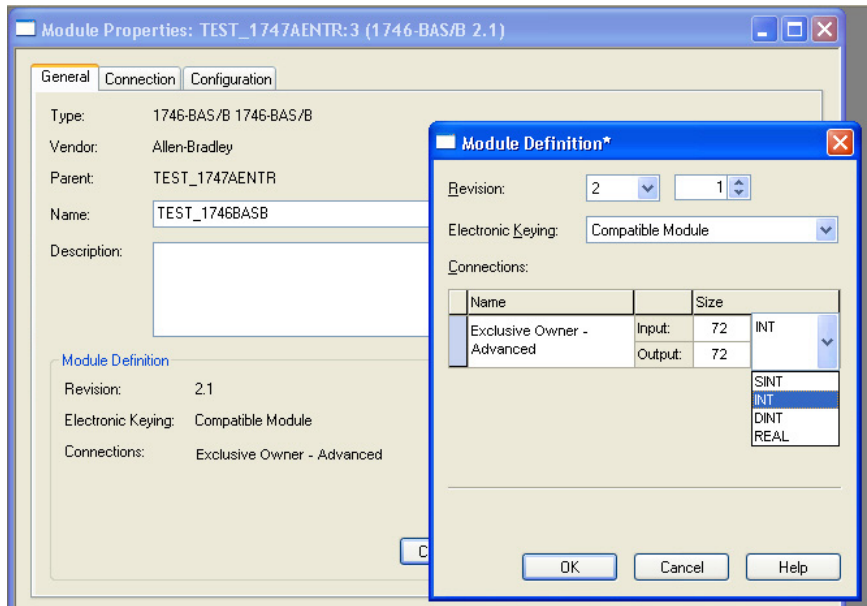

On the Module Definition screen, configure data type as INT, Input Size = 72 (INTs), Output Size = 72 (INTs). The Input Size should match the total size of all three Input Chunks. The Output Size should match the total size of all three Output Chunks. If the I/O sizes are larger than the chunk totals, the adapter will reject the connection request. If the chunk totals are larger than the I/O sizes, the adapter will accept the connection (but the backplane scan may waste cycles reading input data that will never be used).

- Click OK on the Module Definition screen. Then, click Yes on the RSLogix 5000 change confirmation screen that appears.

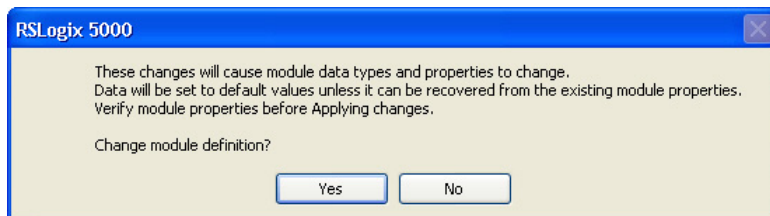

- Click Connection tab. Enter 50 for requested packet interval (RPI) to set how often you exchange data with the I/O adapter.  
Note that Connection is set as Exclusive Owner - Advanced by default.

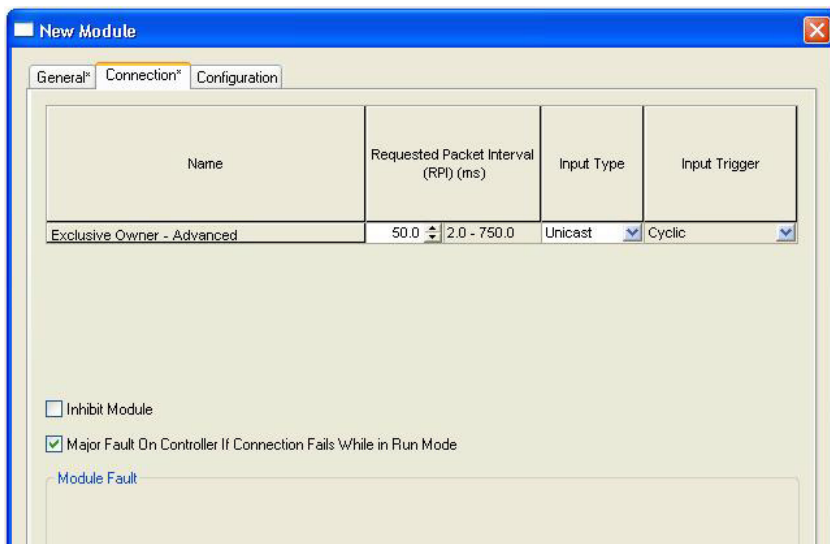

**IMPORTANT** The default RPI of 20 ms is suitable for typical applications.



Rockwell Automation recommends that you check or enable the option "Major Fault On Controller If Connection Fails While in Run Mode" on both the 1747-AENTR device and supported 1746 I/O modules.

- Click Configuration tab.

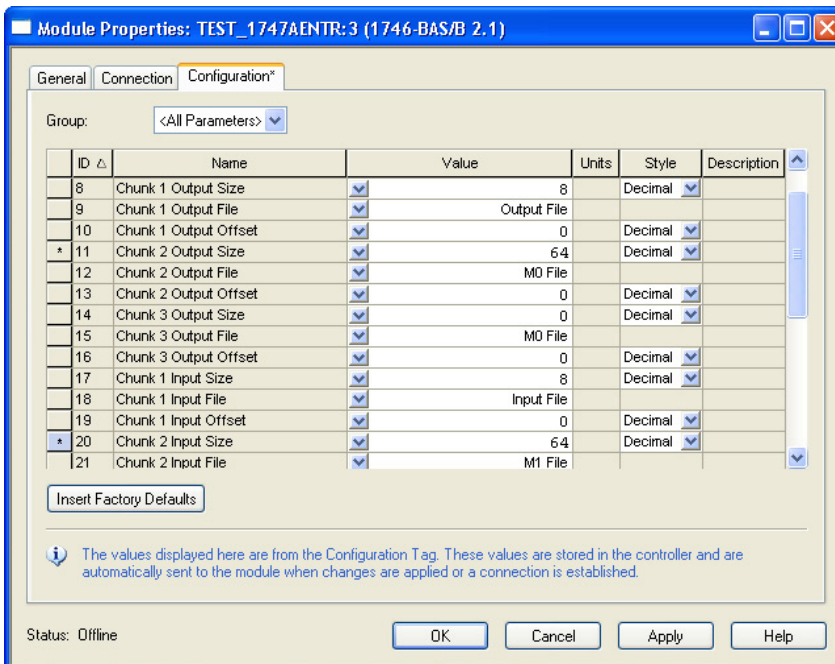

The Chunk configuration determines the 1747-AENTR SLC backplane scan. Set up the chunks as follows:

- Output Chunk 1
  - Size = 8 (number of Output INTs to scan)
  - File = Output File
  - Offset = 0 (starting INT offset in Output File)

- Output Chunk 2
    - Size = 64 (number of Mo INTs to scan)
    - File = Mo File
    - Offset = 0 (starting INT offset in Mo File)
  
  - Output Chunk 3
    - Size = 0
    - File = <Don't Care>
    - Offset = 0
  - Input Chunk 1
    - Size = 8 (number of Input INTs to scan)
    - File = Input File
    - Offset = 0 (starting INT offset in Input File)
  
  - Input Chunk 2
    - Size = 64 (number of M1 INTs to scan)
    - File = M1
    - Offset = 0 (starting INT offset in M1 File)
  
  - Input Chunk 3
    - Size = 0
    - File = <Don't Care>
    - Offset = 0
8. Click OK to save the configuration.
  9. On the Controller Organizer window, right-click Controller Tags under the Controller <name> folder. Select Monitor Tags.

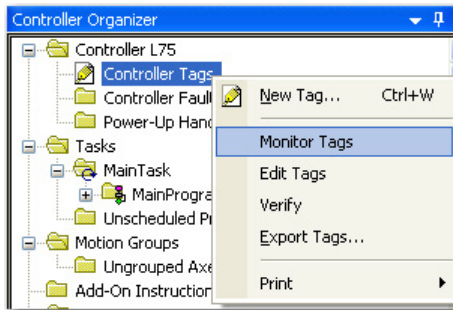

10. Examine the tags created for 1746-BAS/B.

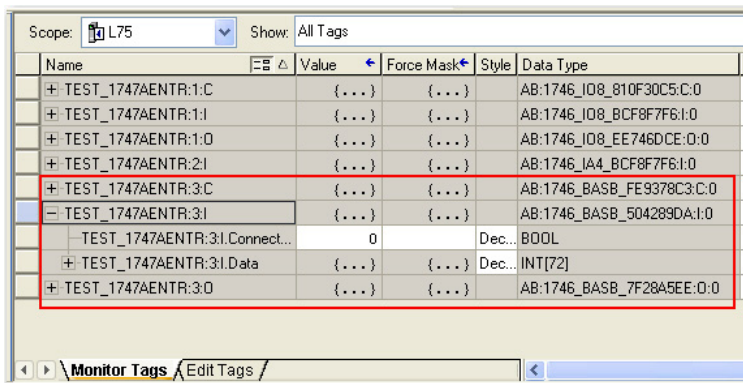

- TEST\_1747AENTR:3:I.Data[0-7] represents Input File data (Input Chunk #1).
- TEST\_1747AENTR:3:I.Data[8-71] represents M1 file data (Input Chunk #2).
- TEST\_1747AENTR:3:O.Data[0-7] represents Output File data (Output Chunk #1).
- TEST\_1747AENTR:3:O.Data[8-71] represents Mo file data (Output Chunk #2).

After adding the 1746-BAS/B module, the I/O Configuration tree should appear as follows:

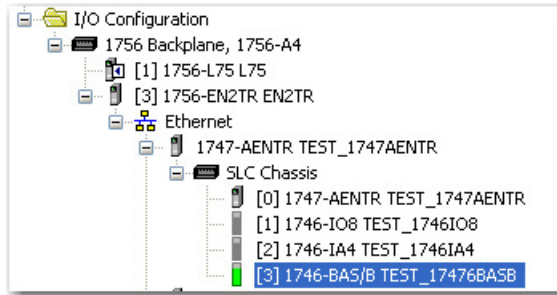

## Download the Program to the Controller

Follow this procedure to download the program you just saved to the ControlLogix controller.

1. From the main menu, choose Communications>Who-Active. The Who Active dialog opens.

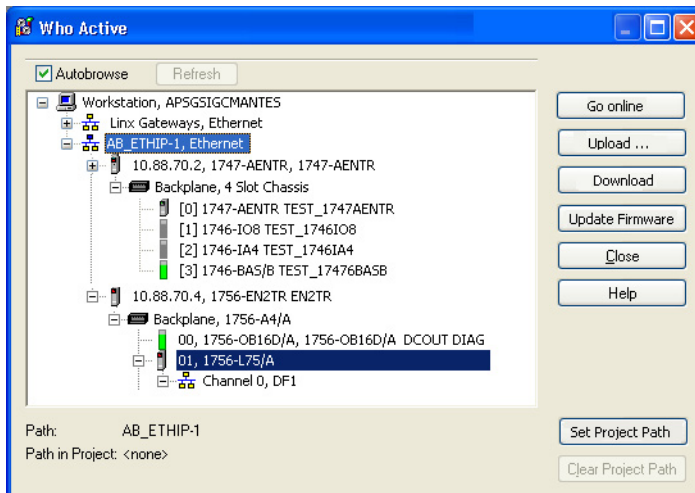

2. Navigate to select the slot where the controller is located in the chassis.
3. Choose Set Project Path.
4. Choose Download. The Download dialog opens with a reminder of the following.
  - The controller is in Remote Run mode.

- The mode changes to Remote Program prior to download.

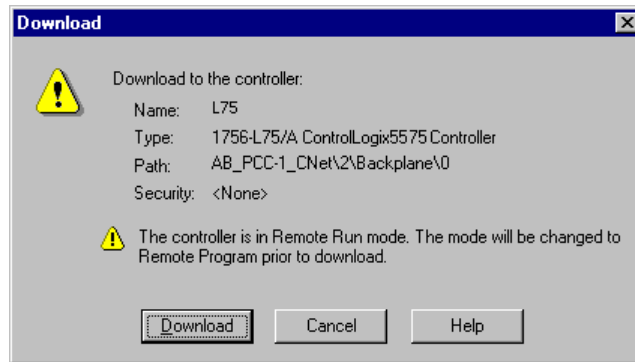

5. On the Download dialog, choose Download. The RSLogix 5000/Studio 5000® software dialog opens.



Notice that the 1756-EN2TR Bridge is now online.

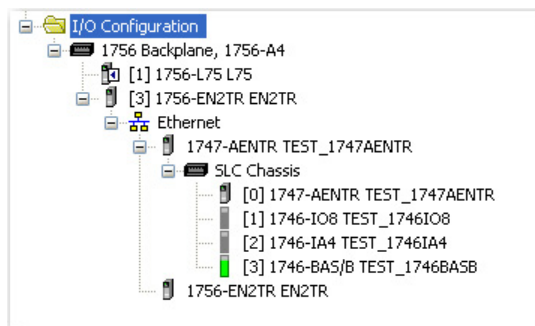

## Custom Settings (Edit Adapter Configuration)

You have now built the I/O Configuration tree in the RSLogix 5000 software. You can edit the configuration of the 1747-AENTR adapter through the Module Properties screen.

The RSLogix 5000 software automatically creates module-defined data types and tags when a module is created. This section describes how to modify the default configuration.

Data types symbolically name module configuration, input and output data. Tags let you provide each a unique name, such as where the user-defined data type and slot reside on the controller. This information is used to communicate data between the controller and module.

Follow these steps to modify the default adapter configuration.

1. In the Project dialog, right-click the 1747-AENTR adapter under I/O Configuration.

2. Select Properties. The following tabs are available for configuration. Tabs can be selected in any order. The following examples are for instructional purposes.

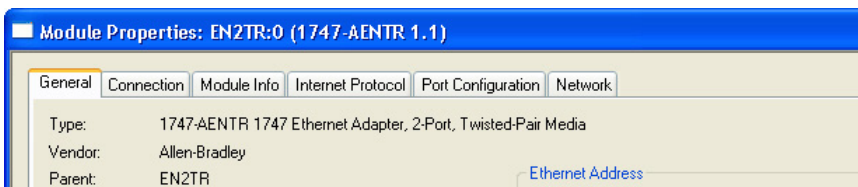

3. Click the Connection tab. Choose from the options in the Connection tab. Note that RPI is not applicable and is left blank.

**Connection Tab Options**

Field Name	Description
Requested Packet Interval (RPI)	RPI is not applicable and is grayed out.
Inhibit module	Check the box to prevent communication between the owner-controller and the module. This option allows for maintenance of the module without faults being reported to the controller.
Major fault On Controller If Connection Fails While in Run Mode	Check the box to create a major fault if there is a connection failure with the module while in Run mode.
Module Fault	The fault box is empty if you are offline. The type of connection fault appears in the text box if a fault occurs when the module is online.



Rockwell Automation recommends that you check or enable the option “Major Fault On Controller If Connection Fails While in Run Mode” on both the 1747-AENTR device and supported 1746 I/O modules.

4. To configure your IP settings, click the Internet Protocol tab. This tab is only available for editing when the device is online.



To manually configure your IP settings, specify the IP address in the Physical Module IP Address field.

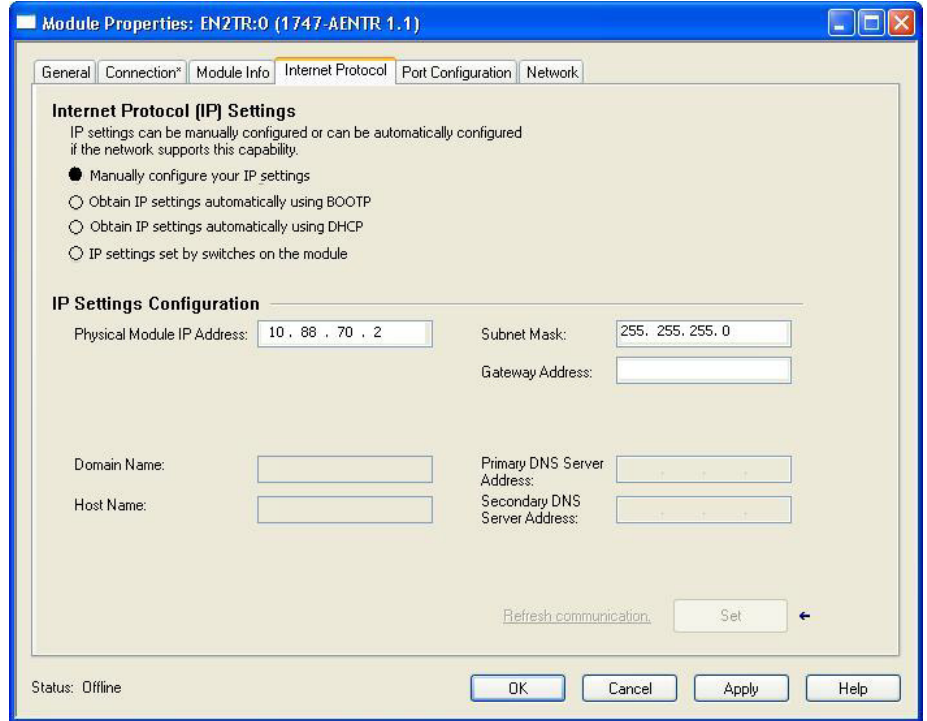

- On the other fields (Domain Name, Host Name, Primary DNS Server Address, Secondary DNS Server Address), specify the corresponding parameter. Click Set and then click OK.

To learn more about how to configure the adapter’s IP settings, see [Configure the Adapter for Your EtherNet/IP Network on page 21](#).

- To configure the Ethernet ports, click the Port Configuration tab. This tab is only available for editing when the device is online.

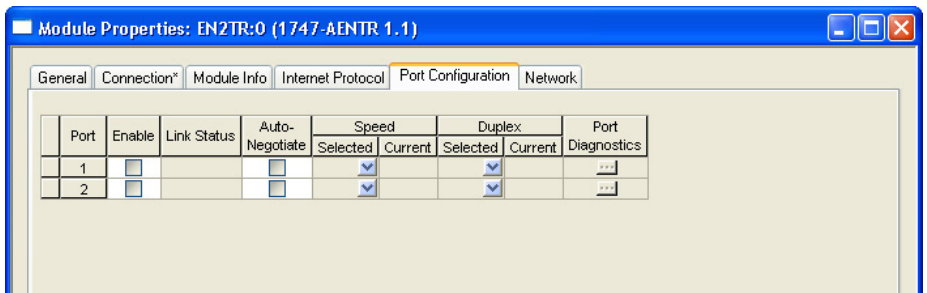

To configure the ports:

To	Then
Use the default port speed and duplex settings	Leave Auto-negotiate port speed and duplex checked. This setting determines the actual speed and duplex setting.
Manually configure your port’s speed and duplex settings	Follow these steps. 1. Clear the Auto-negotiate port speed and duplex checkbox. 2. From the Current Port Speed pull-down menu, choose a port speed. 3. From the Current Duplex pull-down menu, choose the appropriate Duplex value, that is, Half Duplex or Full Duplex.

**IMPORTANT** Consider the following when you configure the module's port settings:

- If the module is connected to an unmanaged switch, leave Auto-negotiate port speed and duplex checked or the module will fail.
- If you are forcing the port speed and duplex with a managed switch, the corresponding port of the managed switch must be forced to the same settings or the module will fail.

7. Click OK.

## Custom Settings for your I/O Module

**IMPORTANT** To fully customize the settings of your I/O module, consult the User Manual for your module. User Manuals and other reference publications for 1746/1747 modules are available in the Rockwell Automation Literature Library: [rok.auto/literature](http://rok.auto/literature)

You can edit the default configuration of your 1746/1747 module through the Module Properties dialog available in RSLogix 5000.

1. On the I/O Configuration tree for your project in RSLogix 5000, right-click the name of your I/O module.

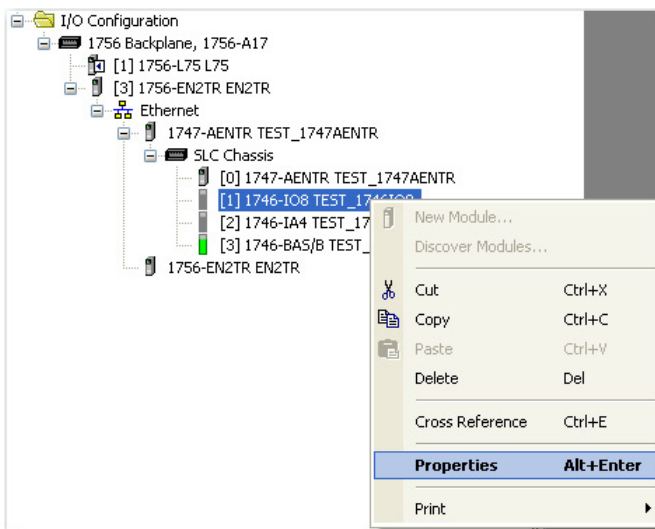

2. Select Properties. The Module Properties dialog appears and has the following tabs available for configuration.

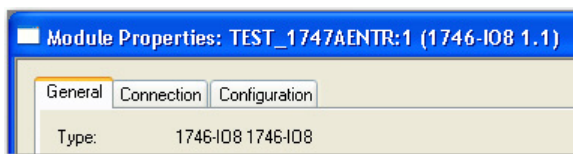

Note that for certain I/O modules, the Configuration tab may not be available.

3. Click Change... on the General tab to access the Module Definition dialog and edit the following information:

- Revision
- Electronic Keying
- Connections

1746-I08 Module Definition shown

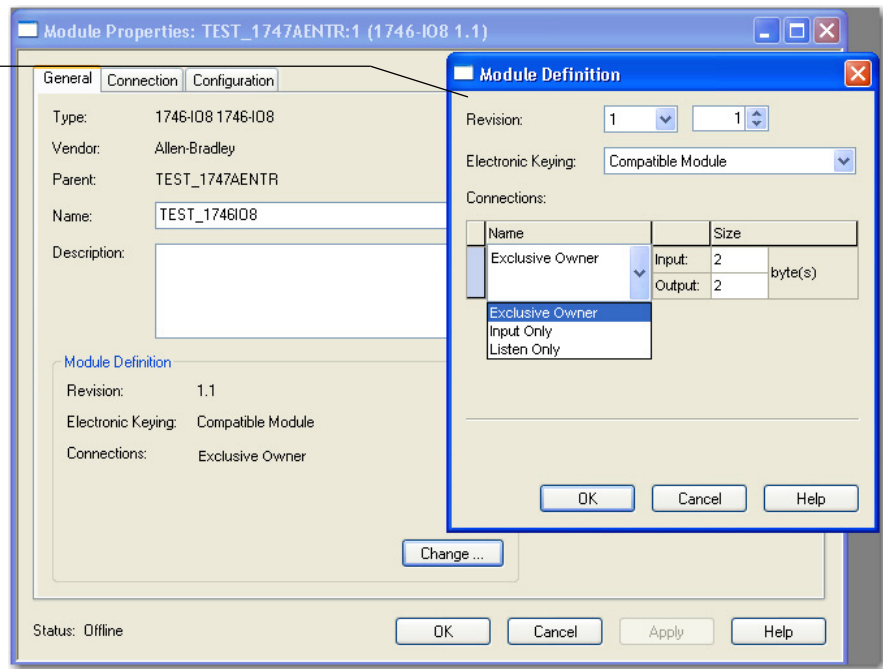

**Module Definition Fields**

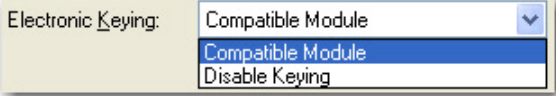
Field	Description
Revision	Specifies the major and minor module revision.
Electronic Keying	<p>The electronic keying feature automatically compares the expected module, as shown in the RSLogix 5000 I/O Configuration tree, to the physical module before I/O communication begins. You can use electronic keying to help prevent communication to a module that does not match the type and revision expected. For each module in the I/O Configuration tree, the user-selected keying option determines if, and how, an electronic keying check is performed. Typically, two keying options are available:</p> <ul style="list-style-type: none"> <li>• Compatible Module</li> <li>• Disable Keying</li> </ul>  <p><b>Compatible Module</b> indicates that the module determines whether to accept or reject communication. Compatible Keying is the default setting. It allows the physical module to accept the key of the module configured in the software, provided that the configured module is one the physical module is capable of emulating. The exact level of emulation required is product and revision specific.</p> <p><b>Disable Keying</b> indicates the keying attributes are not considered when attempting to communicate with a module. Other attributes, such as data size and format, are considered and must be acceptable before I/O communication is established. With Disabled Keying, I/O communication may occur with a module other than the type specified in the I/O configuration tree with unpredictable results. We generally do not recommend using Disabled Keying.</p>
Connections	<p>Defines the type of connection employed by the module. The following options are available for non-specialty I/O modules:</p> <ul style="list-style-type: none"> <li>• Exclusive Owner (default)</li> <li>• Listen Only</li> <li>• Input Only</li> </ul> <p>For specialty I/O modules that require Advanced connections, the following connection options are available:</p> <ul style="list-style-type: none"> <li>• Exclusive Owner - Advanced (default)</li> <li>• Listen Only - Advanced</li> <li>• Input Only - Advanced</li> </ul> <p>To learn more about the different types of connections, see <a href="#">Module Connections on page 29</a>.</p>

4. Click the Connection tab.

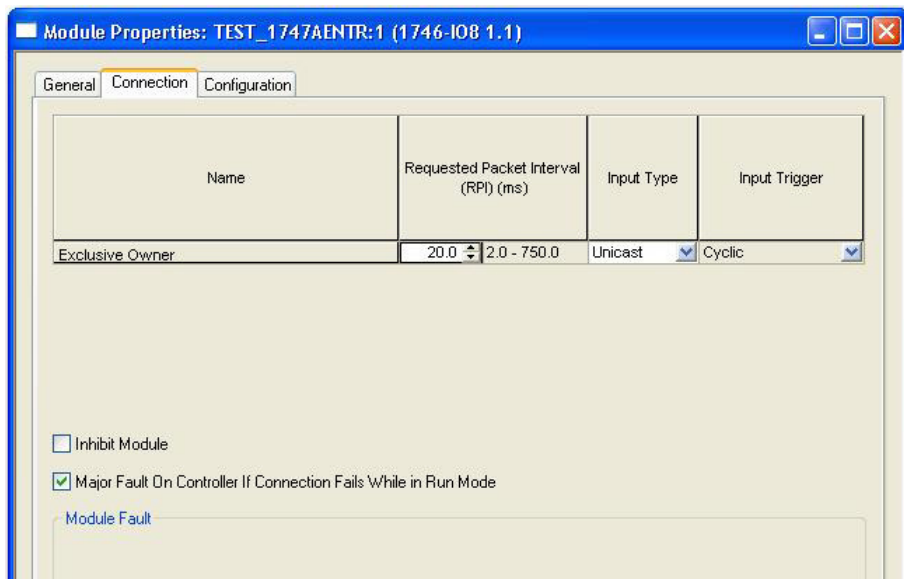

The following information is available and can be configured in the Connection tab.

**Connection Tab Fields**

Field	Description
Name	Specifies the type of connection for the module. Connection type is defined in the Module Definition dialog (see previous step) and cannot be edited in the Connection tab. For more information about Exclusive Owner, Listen Only, and Input Only connections, see <a href="#">Module Connections on page 29</a> .
Requested Packet Interval (RPI) (ms)	A user-defined rate at which the module updates the information sent to its owner-controller. This interval defines the slowest rate at which a module sends its data to the owner-controller. The time ranges from 2.0...750 ms and is sent to the module with all other configuration parameters.
Input type	Defines the input type, whether unicast or multicast, for data sent over the network. The default input type is unicast. <b>Unicast</b> connections are point to point transmissions between a source node and destination node on the network. A Frame is sent to a single destination. <b>Multicast</b> connections deliver information from one sender to multiple receivers simultaneously. Copies of a single frame are passed to a selected subset of possible destinations. Note: The Input Type field cannot be updated for Listen Only and Input Only connections.
Input trigger	Specifies the type of data update. Input trigger is cyclic by default. Data transfer is initiated on a time basis as defined by the requested packet interval (RPI) value. Note: This field cannot be edited on the Connection tab.
Inhibit Module	Check the box to prevent communication between the owner-controller and the module. This option allows for maintenance of the module without faults being reported to the controller.
Major fault On Controller If Connection Fails While in Run Mode	Check the box to create a major fault if there is a connection failure with the module while in Run mode.
Module Fault	The fault box is empty if you are offline. The type of connection fault appears in the text box if a fault occurs when the module is online.

To edit the parameters in the Configuration tab, consult the User Manual specific to your I/O module.

## Online Monitoring

Some of the screens that appear during initial module configuration process are blank (such as Module Info and Network). These tabs provide device information and status and can be important during online monitoring.

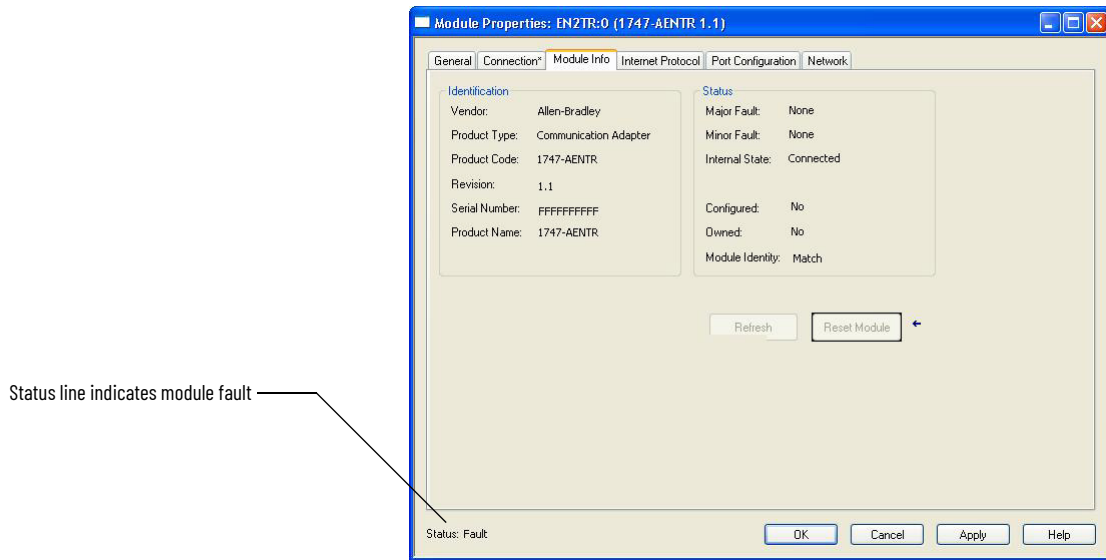

## Chapter Summary

This chapter provided instructions on how to configure the EtherNet/IP adapter for direct connection through the RSLogix 5000 software.

**Notes:**

## Troubleshoot with the Status Indicators

This chapter describes the different status indicators available in the 1747 EtherNet/IP Adapter and how to use them to troubleshoot the module.

### Interpret the Indicators

The module has the following status indicators:

- Module status indicator – indicates the state of the adapter.
- Four-character dot matrix status display – works in conjunction with the Module status indicator to report normal operation and error conditions in your module. It also displays the module IP address.
- Link 1 and Link 2 status indicator – indicates the port speed and activity on Ethernet ports 1 and 2.

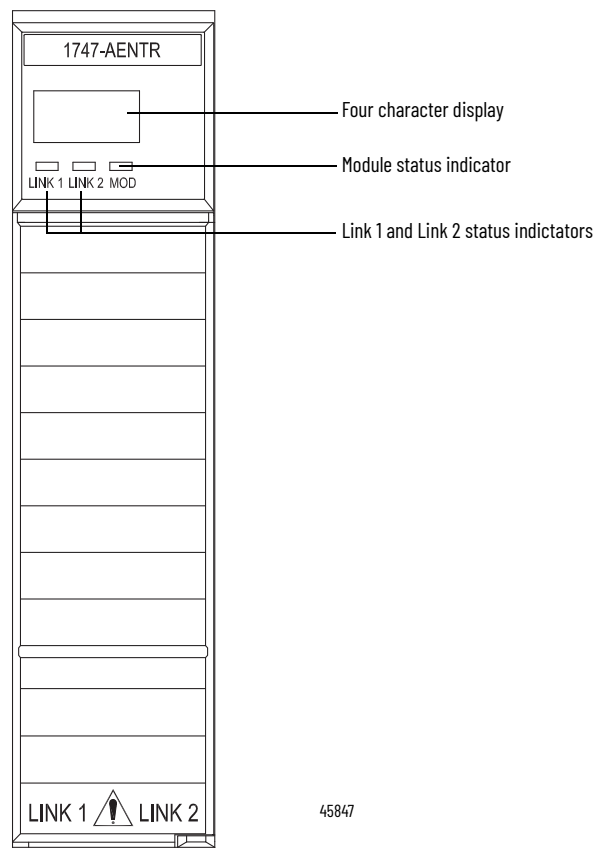

Status Indicators

Indicator	State	Description
Module	Off	No power applied to device
	Green	Device operating normally
	Flashing green	Device has not been configured
	Flashing red	Recoverable fault. <ul style="list-style-type: none"> <li>IP Address switches do not match configuration in use.</li> <li>The device has completed a reset to factory default request because the switches were set to 888 at power up, and a power cycle is required.</li> <li>The device is performing a firmware flash update.</li> </ul>
	Red	Unrecoverable fault, may require device replacement
Four-character Display		Displays IP address and module status description. See table, <a href="#">Four-character Status Display</a> , for a description of all the possible module status.
Link 1 or Link 2	Off	No link established.
	Solid green	Link established @ 100 Mbps.
	Flashing green	Transmit or receive activity present on indicated port @ 100 Mbps.
	Solid yellow	Link established @ 10 Mbps.
	Flashing yellow	Transmit or receive activity present on indicated port @ 10 Mbps.

The four-character display indicates module status as shown in the table below.

Four-character Status Display

MOD LED	Display	Description	Probable Cause	Recommended Action
System startup				
Red-green flash followed by Solid Red	Dotted display on	Module is performing Power On Self Test (POST)	None	None
Green	"OK" (The first scroll cycle displays the software revision in the format " <b>Rev majorRev.minorRev.su bMinorRev</b> ")	POST is successful	None	None
Red	4-digit error hex code (For example, 0100 and 0101)	POST Failure (0100 = JOFPGA failure) (0101=ESFPGA failure)	The adapter has either failed a hardware test, or gone into a state from which it cannot recover.	Document the error codes. Power cycle the adapter. Contact Technical Support.
Flashing Red	"OK" alternates with the message: "Factory Defaults Restored. Change Address Switches and Reset."	Factory defaults restored	Node switches have been set to 888. The AENTR remains in this mode until the switches are changed.	Power off the adapter. Remove the adapter from the chassis. Change the node address switch to something other than 888. Replace the adapter in the chassis, and apply power.
Runtime				



## Four-character Status Display (Continued)

MOD LED	Display	Description	Probable Cause	Recommended Action
Flashing green	"OK" alternates with "Port x baud/dpx" where: x = port number 1 or 2 baud = Link rate, "10" or "100" dpx = "FULL" or "HALF"	Module is communicating.	None	None
	"OK" alternates with "Port x down"	Module is not communicating.	Ethernet port is not connected.	Connect Ethernet port.
	"OK" alternates with "BOOTP XX:XX:XX:XX:XX:XX" or "DHCP XX:XX:XX:XX:XX:XX"	Module is on network waiting for IP address	None	Use RSLinx BootP-DHCP server or set IP statically with thumb wheel switches.
Flashing red	"Duplicate IP XX:XX:XX:XX:XX:XX"	Module is not communicating	The adapter has detected a duplicate node address on the network.	Correct the duplicate node to address problem.
	"Flash update in progress"	Firmware update mode	Adapter firmware is being updated via ControlFlash update utility	None
	"Corrupt Certificate Received"	Firmware update failure	Firmware update with invalid security certificate attempted.	Ensure that you have a valid security certificate to download firmware.
	"Corrupt Image Received"	Firmware update failure	Firmware update with corrupt image has been attempted.	Make sure proper ControlFLASH update procedure is followed. Retry update.
Solid green	<IP address>	Module is communicating and working properly.	None	None
Solid Red	"0001"	Fatal error	The adapter has failed a hardware test, discovered too many racks (that is, greater than 3), or gone into a state from which it cannot recover.	Verify the correct number of I/O racks and power cycle the adapter. Contact Technical Support if problem persists.

## Chapter Summary

This chapter described the different status indicators that can help you troubleshoot the module.

**Notes:**

## Specifications

The 1747-AENTR has the following specifications, ratings, and certifications.

### Ethernet Communication

Attribute	Value
EtherNet communication rate	10/100 Mbps/s, half or full-duplex
Ethernet ports	2, configured as Embedded Switch
Ethernet network topologies supported	Star, Tree, Daisy chain/Linear, and Ring
Ethernet connector	RJ-45, Category 5
Ethernet cable	Category 5: shielded or unshielded

### General Specifications

Attribute	Value
Module location	Always at Slot 0 (leftmost slot) on chassis
Current consumption, backplane	470 mA @ 5V DC
Thermal dissipation	2.49 W = 8.4962 Btu (IT)/hour
Isolation voltage	50V (continuous), Basic Insulation Type
Dimensions (HxWxD), approx.	145.3 x 34.8 x 130.8 mm (5.72 x 1.37 x 5.15 in.)
Enclosure type rating	None (open-style)
Wiring category <sup>(1)</sup>	1 - on communication ports
Weight, approx.	168 g (0.37 lb)
North American temp code	T3C

(1) Use this Conductor Category information for planning conductor routing. Refer to Industrial Automation Wiring and Grounding Guidelines, publication [1770-4.1](#).

### Environmental Specifications

Attribute	Value
Temperature, operating	IEC 60068-2-1 (Test Ad, Operating Cold), IEC 60068-2-2 (Test Bd, Operating Dry Heat), IEC 60068-2-14 (Test Nb, Operating Thermal Shock): 0...60 °C (32...140 °F)
Temperature, nonoperating	IEC 60068-2-1 (Test Ab, Unpackaged Non-operating Cold), IEC 60068-2-2 (Test Bb, Unpackaged Non-operating Dry Heat), IEC 60068-2-14 (Test Na, Unpackaged Non-operating Thermal Shock): -40...+85 °C (-40...+185 °F)
Temperature, surrounding air, max	60 °C (140°F)
Relative humidity	IEC 60068-2-30 (Test Db, Unpackaged Damp Heat): 5...95% noncondensing
Vibration	IEC 60068-2-6 (Test Fc, Operating): 2.5g @ 57...2000Hz
Shock, operating	IEC 60068-2-27 (Test Ea, Unpackaged Shock): 30 g
Shock, nonoperating	IEC 60068-2-27 (Test Ea, Unpackaged Shock): 50 g
Emissions	CISPR 11: Group 1, Class A

**Environmental Specifications (Continued)**

<b>Attribute</b>	<b>Value</b>
ESD immunity	IEC 61000-4-2: 6 kV contact discharges 8 kV air discharges
Radiated RF immunity	IEC 61000-4-3: 10V/m with 1 kHz sine-wave 80% AM from 80...2000 MHz 10V/m with 200 Hz 50% Pulse 100% AM @ 900 MHz 10V/m with 200 Hz 50% Pulse 100% AM @ 1890 MHz 10V/m with 1 kHz sine-wave 80% AM from 2000...2700 MHz
EFT/B immunity	IEC 61000-4-4: ± 3 kV @ 5 kHz on communication ports
Surge transient immunity	IEC 61000-4-5: ± 2 kV line-earth(CM) on communication ports
Conducted RF immunity	IEC 61000-4-6: 10V rms with 1 kHz sine-wave 80% AM from 150 kHz...80 MHz

**Certifications**

<b>Certification (when product is marked)<sup>(1)</sup></b>	<b>Value</b>
c-UL-us	UL Listed Industrial Control Equipment, certified for US and Canada. See UL File E322657. UL Listed for Class I, Division 2 Group A, B, C, D Hazardous Locations, certified for U.S. and Canada. See UL File E334470.
CE	European Union 2004/108/EC EMC Directive, compliant with: EN 61326-1; Meas./Control/Lab., Industrial Requirements EN 61000-6-2; Industrial Immunity EN 61000-6-4; Industrial Emissions EN 61131-2; Programmable Controllers (Clause 8, Zone A & B)
C-Tick	Australian Radiocommunications Act, compliant with: AS/NZS CISPR 11; Industrial Emissions
EtherNet/IP	ODVA conformance tested to EtherNet/IP specifications
KC	Korean Registration of Broadcasting and Communications Equipment, compliant with: Article 58-2 of Radio Waves Act, Clause 3

(1) See the Product Certification link at [rok.auto/certifications](http://rok.auto/certifications) for Declaration of Conformity, Certificates, and other certification details.

## Adapter Web Dialogs

### Overview

The Web dialog of the I/O adapter offers extensive internal and network diagnostics. To view the Web dialogs, enter the IP address of the I/O adapters into your browser.

Topic	Page
Work with the Home Page	61
Work with the Diagnostics Pages	62
Use the Diagnostic Overview Page	63
Use the Network Settings Page	65
Use the Ethernet Statistics Page	66
Use the I/O Connections Page	67
Work with the Configuration Pages	68
Use the Device Identity Page	69
Use the Network Configuration Page	69
Use the Device Services Page	71

### Work with the Home Page

Use the adapter diagnostics home page to access other adapter diagnostics web pages and see the following information.

- Host Name
- Module Description
- Module Location
- IP Address
- Ethernet Address (MAC)
- DHCP Enabled
- Product Revision
- Serial Number
- Status
- Auto Negotiate
- Media Speed
- Half or Full Duplex

To display and work with the adapter diagnostics home page, follow these procedures.

---

**IMPORTANT** Make sure that your PC Internet LAN setting and your TCP/IP settings are configured to access the subnet on which your adapter communicates.

---

1. From your web browser, enter the adapter IP address to see the Home page.

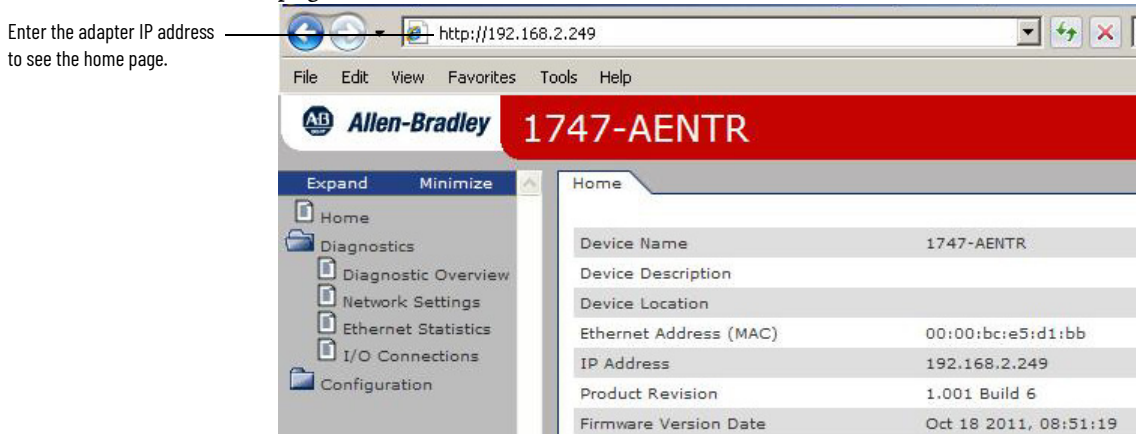

2. From the Home page, click Expand to show options, or minimize to see Diagnostics and Configuration.

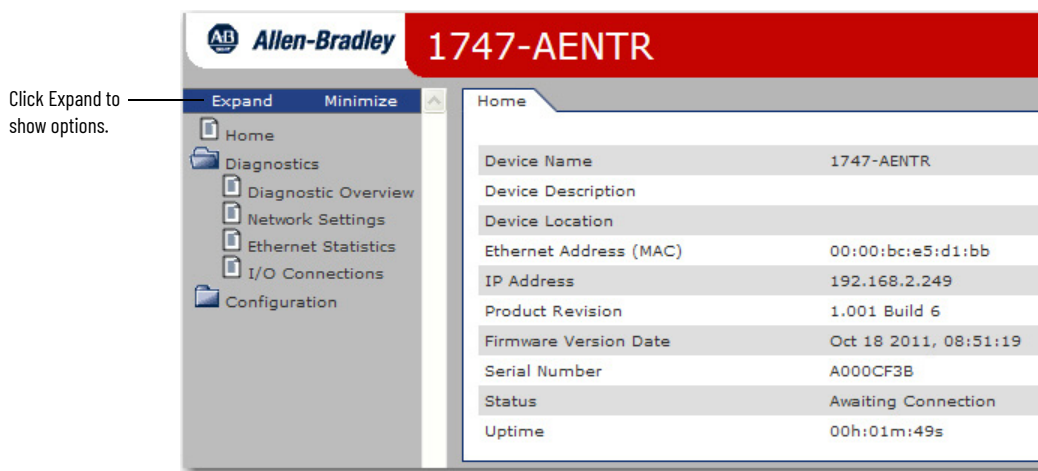

3. From the Home page, complete one of these, as desired.
  - Click one of the following to access [www.ab.com](http://www.ab.com).
    - Allen-Bradley logo at the top of the page
    - Rockwell Automation at the top right to go to [www.rockwellautomation.com](http://www.rockwellautomation.com).
  - Click the following to see additional diagnostics web pages.
    - Diagnostics – Diagnostic overview, Network Settings, Ethernet Statistics, I/O Connections
    - Configuration – Identity, Network, Services

## Work with the Diagnostics Pages

To work with the Diagnostics options, follow these procedures.

1. From the Home page, click Diagnostics or Expand to see the following diagnostics options from the panel at the left.
  - Diagnostic Overview
  - Network Settings
  - Ethernet Statistics
  - I/O Connections
2. In the Refresh Rate field, you can type a refresh rate, noting that the default rate is 15 seconds.

- From the panel at the left or tabs at the top of the page, click one of the diagnostics options to see the corresponding page.

Click tabs to see the corresponding page

Click Diagnostics options to see corresponding pages

Type a refresh rate

Ring Status		Module Settings	
Network Topology	Linear	Switches	999
Network Status	Normal		
Ring Supervisor	0.0.0.0 00:00:00:00:00:00	SLC Backplane Statistics	
		I/O Errors	0
		I/O Scans Completed	1998531
		Maximum Scan time	3 msec
		Average Scan Time	2 msec

System Resource Utilization	
CPU Utilization	4%
Module Uptime	01h:07m:40s

CIP Connection Statics	
Current CIP Msg Connections	0
CIP Msg Connection Limit	8
Max Msg Connections Observed	0
Current CIP I/O Connections	0
CIP I/O Connection Limit	32
Max I/O Connections Observed	0
Conn Opens	0
Open Errors	0
Conn Closes	0
Conn Timeouts	0

Seconds Between Refresh:  Disable Refresh with 0.

## Use the Diagnostic Overview Page

To use the Diagnostic Overview page for general diagnostics information, follow this procedure.

1. Click Diagnostic Overview from the tab at the top of the page or panel on the left.  
The Diagnostic Overview page opens.

The screenshot displays the Diagnostic Overview page for the Allen-Bradley 1747-AENTR module. The page is organized into several sections:

- Ring Status:**
  - Network Topology: Linear
  - Network Status: Normal
  - Ring Supervisor: 0.0.0.0, 00:00:00:00:00:00
- Module Settings:**
  - Switches: 999
- System Resource Utilization:**
  - CPU Utilization: 4%
  - Module Uptime: 01h:07m:40s
- SLC Backplane Statistics:**
  - I/O Errors: 0
  - I/O Scans Completed: 1998531
  - Maximum Scan time: 3 msec
  - Average Scan Time: 2 msec
- CIP Connection Statics:**
  - Current CIP Msg Connections: 0
  - CIP Msg Connection Limit: 8
  - Max Msg Connections Observed: 0
  - Current CIP I/O Connections: 0
  - CIP I/O Connection Limit: 32
  - Max I/O Connections Observed: 0
  - Conn Opens: 0
  - Open Errors: 0
  - Conn Closes: 0
  - Conn Timeouts: 0

At the bottom of the page, there is a refresh control: "Seconds Between Refresh:  Disable Refresh with 0."

2. From the Diagnostic Overview page, you can view the following:
  - Ring Status
    - Network Topology
    - Network Status
    - Ring Supervisor
  - System Resource Utilitization
    - CPU Utilization
    - Module Uptime
  - CIP Connection Statics
    - Current CIP MSG Connections
    - CIP MSG Connection Limit
    - Max Msg Connections Observed
    - Current CIP I/O Connections
    - CIP I/O Connection Limit
    - Max I/O Connections Observed
    - Conn Opens
    - Open Errors
    - Conn Closes
    - Close Errors
    - Conn Timeout



- Module Settings
  - Switches
  
- SLC Backplane Statistics
  - I/O Errors
  - I/O Scans Completed
  - Maximum Scan Time
  - Average Scan Time

## Use the Network Settings Page

To use the Network Settings page for network related information, follow this procedure.

1. Click Network Settings tab at the top of the page or panel on the left. This opens the Network Settings page.

The screenshot displays the Network Settings page for an Allen-Bradley 1747-AENTR device. The interface includes a left-hand navigation pane with options like Home, Diagnostics, Configuration, Device Identity, Network Configuration, and Device Services. The main content area features tabs for Diagnostic Overview, Network Settings, Ethernet Statistics, and I/O Connections. The Network Settings tab is selected, showing configuration for two Ethernet ports. Ethernet Port 1 is active, displaying details such as MAC address (00:00:bc:e5:d1:bb), IP address (192.168.2.249), and Subnet Mask (255.255.255.0). Ethernet Port 2 is inactive. The Ethernet Interface Configuration section shows that the network configuration is obtained dynamically via DHCP.

2. From the Network Settings page, you can view the following:
  - Network Interface
    - Ethernet Address (MAC)
    - IP Address
    - Subnet Mask
    - Default Gateway
    - Primary Name Server
    - Secondary Name Server
    - Default Domain Name
    - Host Name
    - Name Resolution
  
  - Ethernet Interface Configuration
    - How the Network Configuration was obtained - Static or Dynamic

- Ethernet Port 1 and 2
- Interface State
- Link Status
- Media Speed
- Duplex
- Autonegotiate Status

## Use the Ethernet Statistics Page

To use the Ethernet Statistics page for information about the Ethernet link and interface and media counters, use this procedure.

1. Click Ethernet Statistics tab at the top of the page or from the panel on the left.  
The Ethernet Statistics page opens.

The screenshot displays the Ethernet Statistics page for the Allen-Bradley 1747-AENTR device. The page is organized into several sections:

- Ethernet Port 1:**

Interface State	Enabled
Link Status	Active
Media Speed	100 Mbps
Duplex	Full Duplex
Autonegotiate Status	Autonegotiate Speed and Duplex
- Ethernet Port 2:**

Interface State	Enabled
Link Status	Inactive
Media Speed	100 Mbps
Duplex	Full Duplex
Autonegotiate Status	Autonegotiate Speed and Duplex
- Media Counters Port 1:**

Alignment Errors	0
FCS Errors	0
Single Collisions	0
Multiple Collisions	0
SQE Test Errors	0
Deferred Transmissions	0
Late Collisions	0
Excessive Collisions	0
MAC Transmit Errors	0
Carrier Sense Errors	0
Frame Too Long	0
MAC Receive Errors	0
- Media Counters Port 2:**

Alignment Errors	0
FCS Errors	0
Single Collisions	0
Multiple Collisions	0
SQE Test Errors	0
Deferred Transmissions	0
Late Collisions	0
Excessive Collisions	0
MAC Transmit Errors	0
Carrier Sense Errors	0
Frame Too Long	0
MAC Receive Errors	0
- Interface Counters:**

In Octets	102246
In Ucast Packets	544
In NUCast Packets	240
In Discards	0
In Errors	0
In Unknown Protos	0
Out Octets	187162
Out Ucast Packets	499
Out NUCast Packets	40
Out Discards	0
Out Errors	0

2. From the Ethernet Statistics page, you can view the following:
  - Ethernet Port 1 and Port 2
  - Interface State
  - Link Status
  - Media Speed
  - Duplex
  - Autonegotiate Status

- Media Counters Port 1 and Port 2
  - Alignment Errors
  - FCS Errors
  - Single Collisions
  - SQE Test Errors
  - Deferred Transmissions
  - Late Collisions
  - Excessive Collisions
  - MAC Transmit Errors
  - Carrier Sense Errors
  - Frame Too Long
  - MAC Receive Errors
  
- Interface Counters
  - Alignment Errors
  - In Octets
  - In Ucast Packets
  - In NUCast Packets
  - In Discards
  - In Errors
  - In Unknown Protos
  - Out Octets
  - out UCast Packets
  - Out NUCast Packets
  - Out Discards
  - Out Errors

## Use the I/O Connections Page

To use the I/O Connections page for CIP I/O (Class 1) connection information, follow this procedure.

1. Click I/O Connections tab at the top of the page or panel on the left. The I/O Connections page opens.

The top value in this column representing Lost shows the number of packets from the missing source.

The screenshot shows the Allen-Bradley 1747-AENTR web interface. The left sidebar contains a navigation menu with the following items: Home, Diagnostics (Diagnostic Overview, Network Settings, Ethernet Statistics, I/O Connections), and Configuration (Device Identity, Network Configuration, Device Services). The main content area is titled 'I/O Connections' and features a table with the following columns: Conn #, Uptime, Missed Rx Pkts, O-T Conn Id, T-O Conn Id, O-T Size, T-O Size, O-T Type, T-O Type, O-T API (msec), T-O API (msec), and Timeout (msec). Below the table, there is a 'Seconds Between Refresh' field set to 15 and a 'Disable Refresh with 0.' option. The footer of the page reads 'Copyright © 2011 Rockwell Automation, Inc. All Rights Reserved.'

2. From the I/O Connections page, view the following:
  - Connection Number
  - Uptime

- Missed Rx Packets
- O-T (Originator-Target) Connection ID
- T-O (Target-Originator) Connection ID
- O-T (Originator-Target) Size
- T-O (Target-Originator) Size
- O-T (Originator-Target) Type
- T-O (Target-Originator) Type
- O-T (Originator-Target) API
- T-O (Target-Originator) API
- Timeout (msec)

## Work with the Configuration Pages

To work with the Configuration pages, follow these procedures.

---

**IMPORTANT** The values on these pages are in non-volatile memory. Changes to these parameters do not take effect until you reset or cycle power through the I/O adapter.

---

**IMPORTANT** If you set the value of the adapter switch to 888 and then power cycle the module, the following occurs:

- The DHCP Enabled function is enabled (set to True).
- The Ethernet link is negotiated automatically. The Auto Negotiate function is set to True.
- The web server is enabled. The Disabled Web Server function is disabled.
- The Ethernet port are disabled. Both ports are re-enabled once the switches are returned to their previous value and power is cycled.
- The password for this page resets to the factory default which is "<blank>".

Note the value of the switches before you enter the 888 value because you must return the adapter to those values once this process is complete.

---

1. From the Home page, click Configuration or Expand to see the Configuration options, if needed.
2. From the Configuration page, click one of the following:
  - Identity
  - Network
  - Services

A login dialog opens as shown. The dialog may vary in appearance depending on your operating system and browser.



3. From the user name and password dialog, enter values, noting the following:
  - The values for user name and password are case sensitive.
  - The default user name is “administrator”.
  - The default password is “<blank>”.
4. Click OK to log in. After you log in, you can go to any of the Configuration pages without having to log in again.
5. Refer to the section of this manual that corresponds to the section you clicked:
  - Identity
  - Network Configuration
  - Services

## Use the Device Identity Page

To use the Device Identity page to make entries for the device name, device description, and device location, use this procedure.

1. Click Device Identity from the tab at the top of the page or panel on the left.  
The Identity page opens.



2. From the Identity page, complete entries for the following, noting that the description and location help you identify where modules are in the facility:
  - Device Name (this is 1747-AENTR by default)
  - Device Description
  - Device Location
3. Click Apply Changes to save the modified values.

## Use the Network Configuration Page

To use the Network Configuration page to make entries for enabling or disabling DHCP and setting TCP/IP parameters and Ethernet link operation, follow this procedure.

1. Click Network Configuration tab at the top of the page or panel on the left. The Network Configuration page opens.

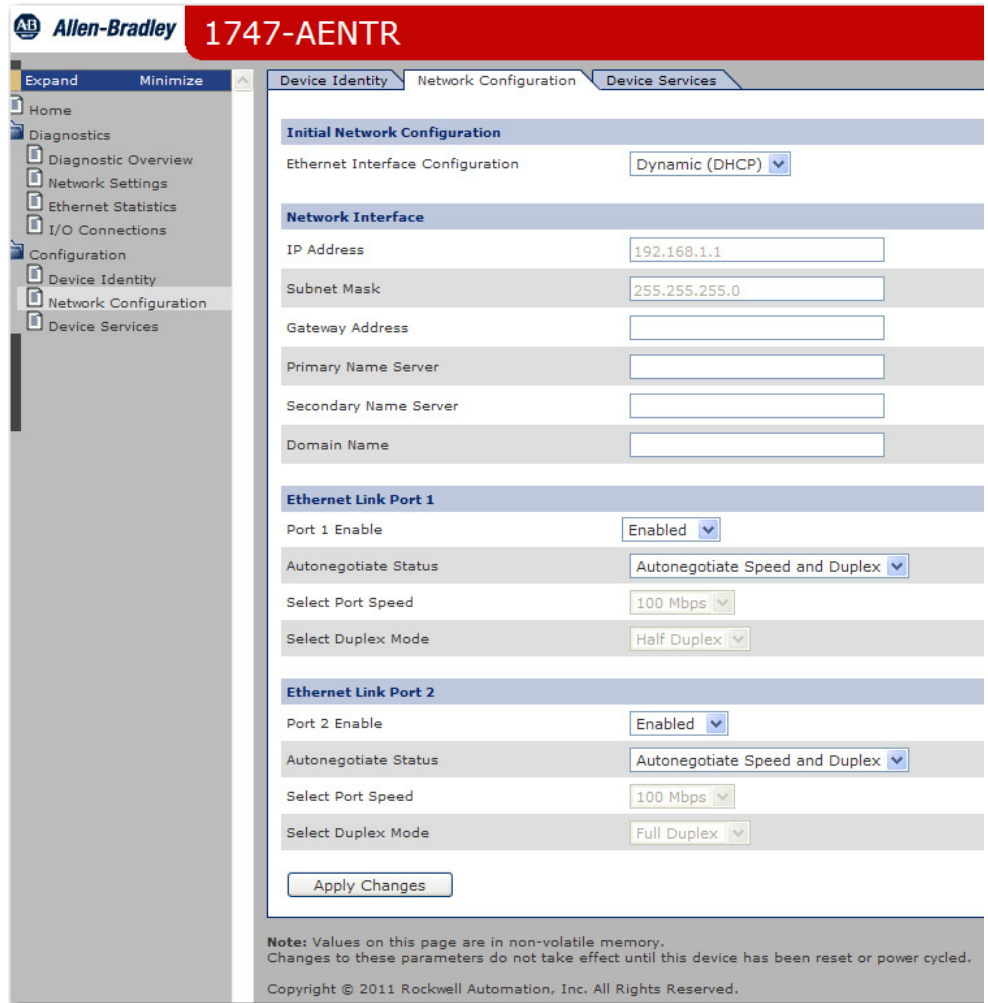

**Allen-Bradley 1747-AENTR**

Device Identity | **Network Configuration** | Device Services

**Initial Network Configuration**

Ethernet Interface Configuration

**Network Interface**

IP Address

Subnet Mask

Gateway Address

Primary Name Server

Secondary Name Server

Domain Name

**Ethernet Link Port 1**

Port 1 Enable

Autonegotiate Status

Select Port Speed

Select Duplex Mode

**Ethernet Link Port 2**

Port 2 Enable

Autonegotiate Status

Select Port Speed

Select Duplex Mode

Note: Values on this page are in non-volatile memory. Changes to these parameters do not take effect until this device has been reset or power cycled.  
Copyright © 2011 Rockwell Automation, Inc. All Rights Reserved.

2. From the Network Configuration page, complete these entries, noting that values for Network Interface are disabled when DHCP is Dynamic and port speed and duplex mode are disabled when Autonegotiate Speed and Duplex is selected.
  - For Initial Network Configuration:
    - Ethernet Interface Configuration
      - Static
      - Dynamic DHCP
  - For Network Interface, fill out these fields:
    - IP Address
    - Subnet Mask
    - Gateway Address
    - Primary Name Server
    - Secondary Name Server
    - Domain Name
  - For Ethernet Link Port 1 and Port 2, specify the following:
    - Autonegotiate Status
      - Autonegotiate Speed and Duplex
      - Force Speed and Duplex

- Select Port Speed – 10 megabits, 100 megabits
  - Select Duplex Mode – Half Duplex, Full Duplex
3. From the Network Configuration page, click Apply Changes to save the modified values.

## Use the Device Services Page

To use the Services page to change the password for the Configuration web page or disable the web server, follow these steps.

1. Click Device Services tab at the top of the page or panel on the left. The Device Services page opens.

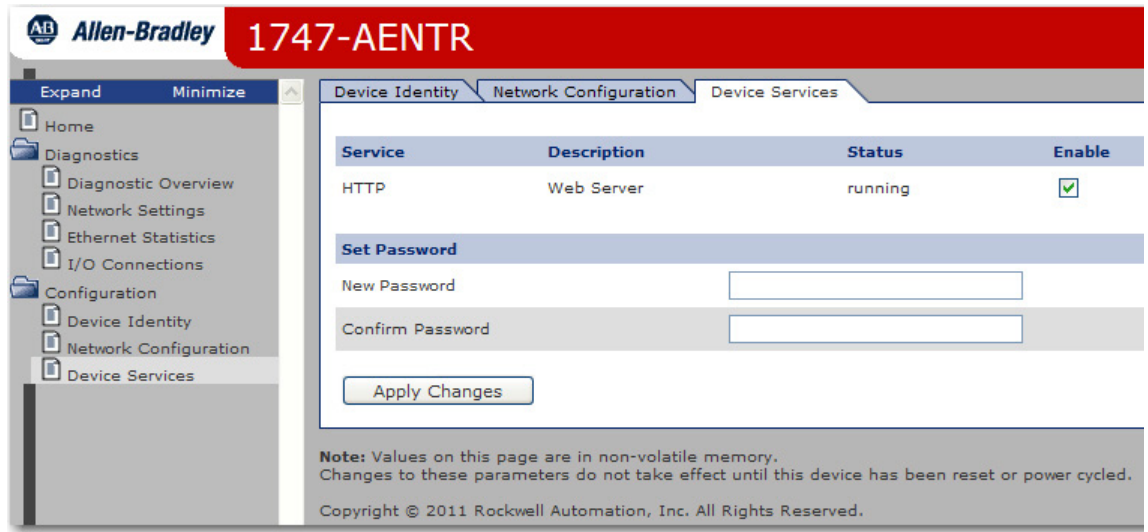

2. From the Services page, make these entries.
  - Click the Enable box to change whether the web server runs after the module is reset.
  - Change the password by typing a new value for New Password and Confirm Password, noting the following:
    - The entry is case sensitive.
    - The default value is <blank>.
3. Click Apply Changes.

**Notes:**



## Configure the RSLinx Ethernet Communication Driver

### Overview

To communicate with your adapter over your network, you must configure the RSLinx EtherNet/IP driver (AB-ETHIP). You can configure the AB\_ETH driver with the IP addresses of all the Ethernet devices on your system. You need one of these drivers to download the example application programs in this manual.

See the table for a list of the contents of this appendix.

Topic	Page
Install the RSLinx Software	73
Configure the AB_ETH/IP Driver	73

### Install the RSLinx Software

Use this procedure to install the RSLinx software on your computer.

1. Insert the CD in the CD-ROM drive.

Note that the CD-ROM supports Windows Autorun. Once inserted into the CD-ROM drive, if you have Autorun configured, the installation automatically starts at the first setup screen.

If Autorun is not configured for your CD-ROM drive, go to step 2.

2. From the Start menu, choose Run. The Run dialog opens.
3. Type D:/setup (if it doesn't appear automatically), where D: is your CD-ROM drive letter.
4. Click OK.  
The progress bar, followed by the welcome screen opens

### Configure the AB\_ETH/IP Driver

To configure the AB-ETHIP Ethernet communication driver, perform the following steps.

1. Start the RSLinx software.

- From the Communications menu, select Configure Drivers.

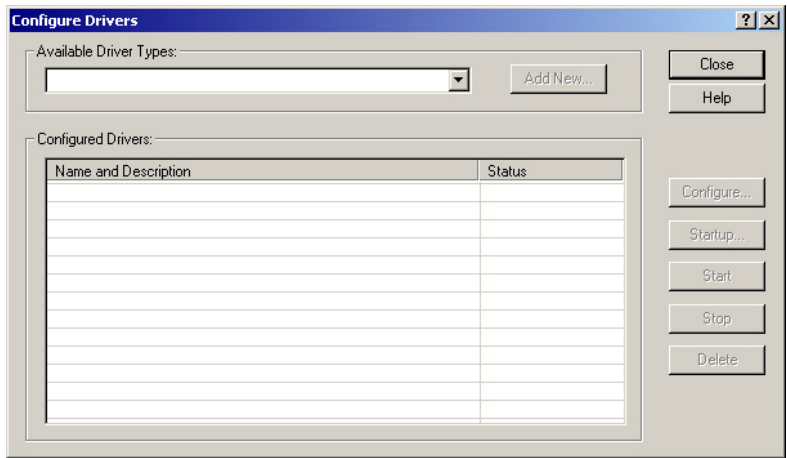

- Select EtherNet/IP Devices from the list and click Add/New...

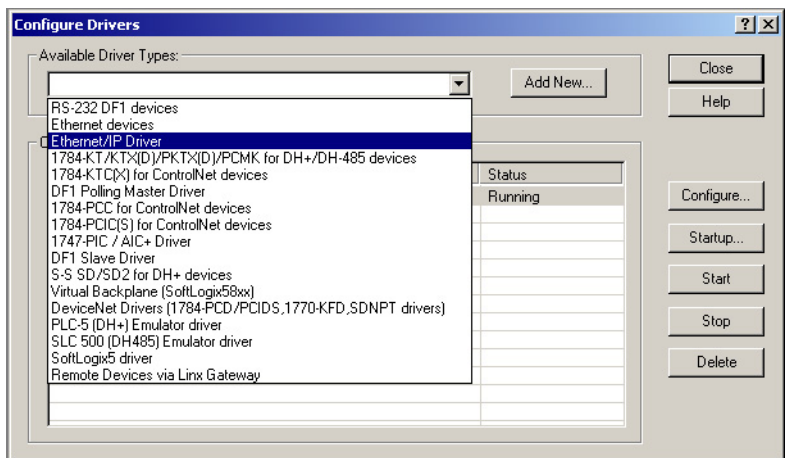

The Configure Dialog box opens.

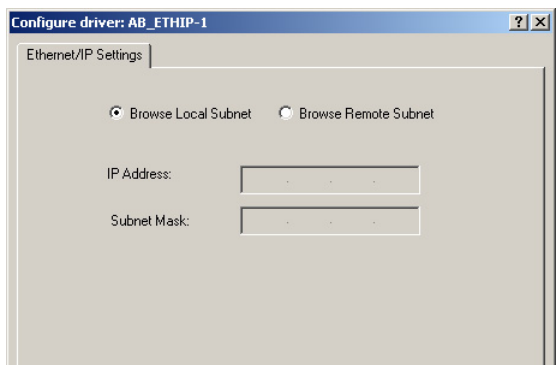

Make sure the Browse Local Subnet button is selected.

The RSLinx software browses your local subnet and automatically reads the IP address.

- Click OK.  
The AB-ETHIP driver is now configured and appears in the configured drivers window.

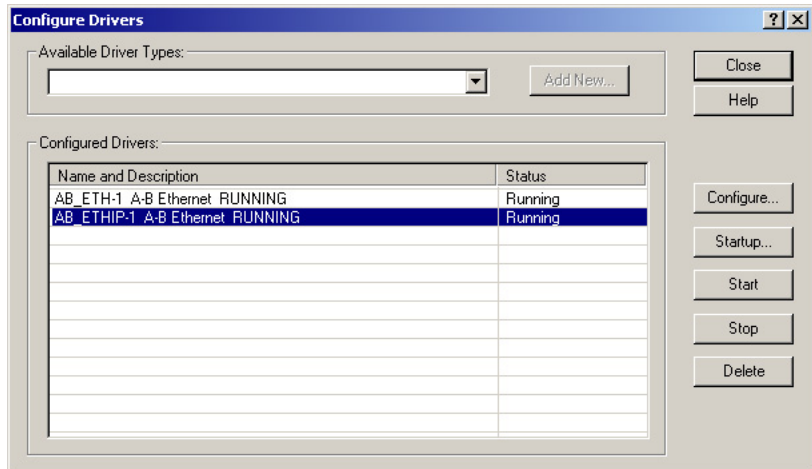

- Close the RSLinx software.

**Notes:**

## Numerics

- 1746-BAS/B** 33, 42
- 1746-IA4** 33
- 1746-I08** 33
- 1747-AENTR** 29
  - configuration 33
  - connect through RJ-45 19
  - custom settings 47
  - drawing 10
  - installation 15
  - ratings 59
  - specifications 59
  - status indicators 55
- 1756-EN2TR** 33, 34

## A

- adapter** 29
  - mounted 33
- adapter operation** 29
- auto negotiate** 16, 61

## B

- backplane** 9, 18, 29, 44
- BootP/DHCP** 15, 21
  - relation List 25

## C

- certifications**
  - CE 60
  - C-Tick 60
  - c-UL-us 60
  - KC 60
  - ODVA 60
- chassis** 18
  - ControlLogix 33
  - size 38
  - SLC 42
- chunk configuration** 44
- CIP (Common Industrial Protocol)** 12
- communication with I/O modules** 29
- CompactLogix** 9
- compatibility**
  - 1746/1747 modules 27
  - hardware/software 11
- conducted RF immunity** 60
- configuration**
  - chunk 44
  - for EtherNet/IP network 21
  - through RSLogix 5000 33
- configure**
  - adapter 33
  - for direct connection 33
- connection** 33
  - direct 29, 33
  - maximum 29
  - simple 42

- connections** 29, 30
  - advanced 42
- controller** 34
  - ControlLogix 33
  - L63 33
  - Logix 11
  - tags 45
- ControlLogix** 9, 33
- current consumption** 59
- cyclic trigger** 12

## D

- DHCP** 15, 26
- DHCP Enabled** 61
- DHCP enabled** 15
- direct** 33
- direct connection** 12, 33
- domain name** 49
- download**
  - program 46

## E

- EFT/B immunity** 60
- electronic keying** 30, 36, 38
- emissions** 59
- enclosure type rating** 59
- ESD immunity** 60
- EtherNet/IP** 12
- Exclusive Owner** 29

## F

- fault** 30, 48
- ForwardOpen** 29

## G

- gateway address** 22

## H

- hardware**
  - components 10
  - setup 33

## I

- I/O**
  - modules 33
- I/O Configuration** 35
  - add 1747-AENTR 37
  - add I/O module 39
- I/O configuration**
  - add Ethernet bridge 35
- IEEE 802.1 ID** 29
- IEEE 802.3** 29

**indicator**

- Link 1 status 10
- Link 2 status 10
- Link1 and Link 2 55
- status 10, 55

**indicators**

- diagnostic 11
- troubleshoot with 55

**inhibit module** 48**Input Only** 30**installation** 15**IP address** 21, 34, 62**isolation voltage** 59**L****latch** 10**Listen Only** 30**Logix system** 11**M****master and slave** 12**media speed** 61**mode** 30**module** 29

- dimensions 59
- inhibit 48
- location 59
- revision 38

**Module Properties** 50

- General tab 38
- Internet Protocol 48

**multicast** 12**O****operation** 29**P****ports** 29

- auto-negotiate speed 49
- Ethernet 49
- speed 49

**power supply** 33**producer-consumer** 12**R****Radiated RF immunity** 60**ratings** 59**relation list** 25**relative humidity** 59**requirements** 29

- configuration 21
- power 18

**RJ-45** 10

- wire 19

**RPI** 12, 40, 41, 44

- default value 41

**RSLinx** 11, 21, 29, 34

- configure Ethernet driver 73
- install 73

**RSLogix 5000** 11, 21, 24, 29, 33, 47, 50

- connection properties 44
- custom settings for I/O modules 50
- Module Definition 43

**S****sample application** 34**shock**

- nonoperating 59

**shock, operating** 59**SLC backplane** 9**software** 29**software requirements** 29**specifications** 59

- environmental 59
- Ethernet communication 59
- general 59

**status indicators** 55**subnet mask** 21, 23**surge transient immunity** 60**switches**

- network 10, 15, 21

**T****T3C** 59**TCP** 16**temperature**

- nonoperating 59
- operating 59
- surrounding air 59

**thermal dissipation** 59**troubleshooting** 55**U****unicast** 12**V****vibration** 59**W****web server** 16, 61

- diagnostic overview 63
- home page 61
- I/O Connections 67
- network settings 65

**weight** 59**wiring category** 59



# Rockwell Automation Support

Use these resources to access support information.

<b>Technical Support Center</b>	Find help with how-to videos, FAQs, chat, user forums, and product notification updates.	<a href="http://rok.auto/support">rok.auto/support</a>
<b>Knowledgebase</b>	Access Knowledgebase articles.	<a href="http://rok.auto/knowledgebase">rok.auto/knowledgebase</a>
<b>Local Technical Support Phone Numbers</b>	Locate the telephone number for your country.	<a href="http://rok.auto/phonesupport">rok.auto/phonesupport</a>
<b>Literature Library</b>	Find installation instructions, manuals, brochures, and technical data publications.	<a href="http://rok.auto/literature">rok.auto/literature</a>
<b>Product Compatibility and Download Center (PCDC)</b>	Download firmware, associated files (such as AOP, EDS, and DTM), and access product release notes.	<a href="http://rok.auto/pcdc">rok.auto/pcdc</a>

## Documentation Feedback

Your comments help us serve your documentation needs better. If you have any suggestions on how to improve our content, complete the form at [rok.auto/docfeedback](http://rok.auto/docfeedback).

## Waste Electrical and Electronic Equipment (WEEE)



At the end of life, this equipment should be collected separately from any unsorted municipal waste.





Rockwell Automation maintains current product environmental compliance information on its website at [rok.auto/pec](http://rok.auto/pec).

Allen-Bradley, CompactLogix, ControlLogix, expanding human possibility, FactoryTalk, Logix 5000, PanelView, Rockwell Automation, RSLinx, RSLogix 5000, SLC, SLC 500, Studio 5000, Studio 5000 Logix Designer, and TechConnect are trademarks of Rockwell Automation, Inc.

CIP, ControlNet, DeviceNet, and EtherNet/IP are trademarks of ODVA, Inc.

Trademarks not belonging to Rockwell Automation are property of their respective companies.

Rockwell Otomasyon Ticaret A.Ş. Kar Plaza İş Merkezi E Blok Kat:6 34752, İçerenköy, İstanbul, Tel: +90 (216) 5698400 EEE Yönetmeliğine Uygundur

Connect with us.    

**rockwellautomation.com** — expanding **human possibility**

AMERICAS: Rockwell Automation, 1201 South Second Street, Milwaukee, WI 53204-2496 USA, Tel: (1) 414.382.2000, Fax: (1) 414.382.4444  
EUROPE/MIDDLE EAST/AFRICA: Rockwell Automation NV, Pegasus Park, De Kleetlaan 12a, 1831 Diegem, Belgium, Tel: (32) 2 663 0600, Fax: (32) 2 663 0640  
ASIA PACIFIC: Rockwell Automation, Level 14, Core F, Cyberport 3, 100 Cyberport Road, Hong Kong, Tel: (852) 2887 4788, Fax: (852) 2508 1846

Publication 1747-UM076E-EN-E - August 2021

Supersedes Publication 1747-UM076D-EN-E - January 2019

Copyright © 2021 Rockwell Automation, Inc. All rights reserved.