



# POINT I/O Field Potential Distributor Modules

Catalog Numbers 1734-FPD, 1734-FPDK, Series B

Catalog numbers with the suffix 'K' are conformal coated and their specifications are the same as non-conformal coated catalogs.

## Table of Contents

<b>Topic</b>	<b>Page</b>
Important User Information	2
Environment and Enclosure	3
Prevent Electrostatic Discharge	3
North American Hazardous Location Approval	4
European Hazardous Location Approval	5
Before You Begin	7
Install the Module	8
Remove the Module	9
Replace the Module	9
Wire the Module	10
Specifications	13

### Important User Information

Solid-state equipment has operational characteristics differing from those of electromechanical equipment. Safety Guidelines for the Application, Installation and Maintenance of Solid-State Controls (Publication [SGI-1.1](#) available from your local Rockwell Automation sales office or online at <http://www.rockwellautomation.com/literature/>) describes some important differences between solid-state equipment and hard-wired electromechanical devices. Because of this difference, and also because of the wide variety of uses for solid-state equipment, all persons responsible for applying this equipment must satisfy themselves that each intended application of this equipment is acceptable.





In no event will Rockwell Automation, Inc. be responsible or liable for indirect or consequential damages resulting from the use or application of this equipment.

The examples and diagrams in this manual are included solely for illustrative purposes. Because of the many variables and requirements associated with any particular installation, Rockwell Automation, Inc. cannot assume responsibility or liability for actual use based on the examples and diagrams.

No patent liability is assumed by Rockwell Automation, Inc. with respect to use of information, circuits, equipment, or software described in this manual.

Reproduction of the contents of this manual, in whole or in part, without written permission of Rockwell Automation, Inc., is prohibited.

Throughout this manual, when necessary, we use notes to make you aware of safety considerations.

	<b>WARNING:</b> Identifies information about practices or circumstances that can cause an explosion in a hazardous environment, which may lead to personal injury or death, property damage, or economic loss.
	<b>ATTENTION:</b> Identifies information about practices or circumstances that can lead to personal injury or death, property damage, or economic loss. Attentions help you identify a hazard, avoid a hazard and recognize the consequences.
	<b>SHOCK HAZARD:</b> Labels may be on or inside the equipment (for example, drive or motor) to alert people that dangerous voltage may be present.
	<b>BURN HAZARD:</b> Labels may be on or inside the equipment (for example, drive or motor) to alert people that surfaces may reach dangerous temperatures.
<b>IMPORTANT</b>	Identifies information that is critical for successful application and understanding of the product.

---

## Environment and Enclosure

---



**ATTENTION:** This equipment is intended for use in a Pollution Degree 2 industrial environment, in overvoltage Category II applications (as defined in EN/IEC 60664-1), at altitudes up to 2000 m (6562 ft) without derating.

This equipment is not intended for use in residential environments and may not provide adequate protection to radio communication services in such environments.

This equipment is supplied as open-type equipment for indoor use. It must be mounted within an enclosure that is suitably designed for those specific environmental conditions that will be present and appropriately designed to prevent personal injury resulting from accessibility to live parts. The enclosure must have suitable flame-retardant properties to prevent or minimize the spread of flame, complying with a flame spread rating of 5VA or be approved for the application if nonmetallic. The interior of the enclosure must be accessible only by the use of a tool. Subsequent sections of this publication may contain more information regarding specific enclosure type ratings that are required to comply with certain product safety certifications.

In addition to this publication, see the following:

- Industrial Automation Wiring and Grounding Guidelines, publication [1770-4.1](#), for more installation requirements.
- NEMA Standard 250 and EN/IEC 60529, as applicable, for explanations of the degrees of protection provided by enclosures.

---

## Prevent Electrostatic Discharge



---



**ATTENTION:** This equipment is sensitive to electrostatic discharge that can cause internal damage and affect normal operation. Follow these guidelines when you handle this equipment:

- Touch a grounded object to discharge potential static.
  - Wear an approved grounding wriststrap.
  - Do not touch connectors or pins on component boards.
  - Do not touch circuit components inside the equipment.
  - Use a static-safe workstation if available.
  - Store the equipment in appropriate static-safe packaging when not in use.
-

### North American Hazardous Location Approval

<b>The following information applies when operating this equipment in hazardous locations:</b>	<b>Informations sur l'utilisation de cet équipement en environnements dangereux:</b>
<p>Products marked "CL I, DIV 2, GP A, B, C, D" are suitable for use in Class I Division 2 Groups A, B, C, D, Hazardous Locations and nonhazardous locations only. Each product is supplied with markings on the rating nameplate indicating the hazardous location temperature code. When combining products within a system, the most adverse temperature code (lowest "T" number) may be used to help determine the overall temperature code of the system. Combinations of equipment in your system are subject to investigation by the local Authority Having Jurisdiction at the time of installation.</p>	<p>Les produits marqués "CL I, DIV 2, GP A, B, C, D" ne conviennent qu'à une utilisation en environnements de Classe I Division 2 Groupes A, B, C, D dangereux et non dangereux. Chaque produit est livré avec des marquages sur sa plaque d'identification qui indiquent le code de température pour les environnements dangereux. Lorsque plusieurs produits sont combinés dans un système, le code de température le plus défavorable (code de température le plus faible) peut être utilisé pour déterminer le code de température global du système. Les combinaisons d'équipements dans le système sont sujettes à inspection par les autorités locales qualifiées au moment de l'installation.</p>
<div style="display: flex; align-items: center;">  <div> <p><b>EXPLOSION HAZARD</b></p> <ul style="list-style-type: none"> <li>• Do not disconnect equipment unless power has been removed or the area is known to be nonhazardous.</li> <li>• Do not disconnect connections to this equipment unless power has been removed or the area is known to be nonhazardous. Secure any external connections that mate to this equipment by using screws, sliding latches, threaded connectors, or other means provided with this product.</li> <li>• Substitution of components may impair suitability for Class I, Division 2.</li> </ul> </div> </div>	<div style="display: flex; align-items: center;">  <div> <p><b>RISQUE D'EXPLOSION</b></p> <ul style="list-style-type: none"> <li>• Couper le courant ou s'assurer que l'environnement est classé non dangereux avant de débrancher l'équipement.</li> <li>• Couper le courant ou s'assurer que l'environnement est classé non dangereux avant de débrancher les connecteurs. Fixer tous les connecteurs externes reliés à cet équipement à l'aide de vis, loquets coulissants, connecteurs filetés ou autres moyens fournis avec ce produit.</li> <li>• La substitution de composants peut rendre cet équipement inadapté à une utilisation en environnement de Classe I, Division 2.</li> </ul> </div> </div>

---

## European Hazardous Location Approval

---

### The following applies to products marked **CE** **Ex** **II 3 G**:

- Are intended for use in potentially explosive atmospheres as defined by European Union Directive 2014/34/EU and has been found to comply with the Essential Health and Safety Requirements relating to the design and construction of Category 3 equipment intended for use in Zone 2 potentially explosive atmospheres, given in Annex II to this Directive.
- Compliance with the Essential Health and Safety Requirements has been assured by compliance with EN 60079-15 and EN 60079-0.
- Are Equipment Group II, Equipment Category 3, and comply with the Essential Health and Safety Requirements relating to the design and construction of such equipment given in Annex II to Directive 2014/34/EU. See the EC Declaration of Conformity at <http://www.rockwellautomation.com/global/certification/overview.page> for details.
- The type of protection is Ex nA IIC T4 Gc according to EN 60079-15.
- Comply to Standards EN 60079-0:2012+A11:2013, EN 60079-15:2010, reference certificate number DEMKO 04 ATEX 0330347X.
- Are intended for use in areas in which explosive atmospheres caused by gases, vapors, mists, or air are unlikely to occur, or are likely to occur only infrequently and for short periods. Such locations correspond to Zone 2 classification according to ATEX directive 2014/34/EU.
- May have catalog numbers followed by a "K" to indicate a conformal coating option.



### **WARNING: Special Conditions for Safe Use:**

- This equipment is not resistant to sunlight or other sources of UV radiation.
- This equipment shall be mounted in an ATEX/IECEx Zone 2 certified enclosure with a minimum ingress protection rating of at least IP54 (in accordance with EN/IEC 60079-15) and used in an environment of not more than Pollution Degree 2 (as defined in EN/IEC 60664-1) when applied in Zone 2 environments. The enclosure must be accessible only by the use of a tool.
- This equipment shall be used within its specified ratings defined by Rockwell Automation.
- Provision shall be made to prevent the rated voltage from being exceeded by transient disturbances of more than 140% of the peak rated voltage when applied in Zone 2 environments.
- The instructions in the user manual shall be observed.
- This equipment must be used only with ATEX certified Rockwell Automation backplanes.
- Earthing is accomplished through mounting of modules on rail.
- Devices shall be used in an environment of not more than Pollution Degree 2.



**ATTENTION:** If this equipment is used in a manner not specified by the manufacturer, the protection provided by the equipment may be impaired.

**ATTENTION:** Read this document and the documents listed in the Additional Resources section about installation, configuration, and operation of this equipment before you install, configure, operate, or maintain this product. Users are required to familiarize themselves with installation and wiring instructions in addition to requirements of all applicable codes, laws, and standards.

**ATTENTION:** Installation, adjustments, putting into service, use, assembly, disassembly, and maintenance are required to be carried out by suitably trained personnel in accordance with applicable code of practice.

**ATTENTION:** In case of malfunction or damage, no attempts at repair should be made. The module should be returned to the manufacturer for repair. Do not dismantle the module.

**ATTENTION:** This equipment is certified for use only within the surrounding air temperature range of -20...+55 °C (-4...+131 °F). The equipment must not be used outside of this range.

**ATTENTION:** Use only a soft dry anti-static cloth to wipe down equipment. Do not use any cleaning agents.

---

---



**WARNING:** Secure any external connections that mate to this equipment by using screws, sliding latches, threaded connectors, or other means provided with this product.

**WARNING:** Do not disconnect equipment unless power has been removed or the area is known to be nonhazardous.

**WARNING:** The secondary of a current transformer shall not be open-circuited when applied in Class I, Zone 2 environments.

---

---

## Before You Begin

The purpose of the module is to break the field power distribution.

Use the module to change the field power distribution source for I/O modules to the right of the module. This facilitates logical or functional partitioning of low-channel count, high I/O-mix applications using the 1734-adapters, 1734-PDN, and 1734D Series communication interfaces. This module passes through all POINT I/O™ backplane signals except the internal field power bus for field devices.

You can use the module with a range of voltage inputs to include the following:

- 5...250V DC applications
- 24...240V AC applications
- I/O modules

## POINT I/O Field Potential Distributor Module

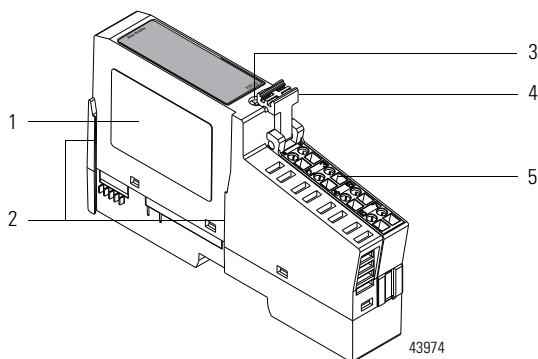

	Description		Description
1	Module label	4	Removable terminal block handle
2	Interlocking side pieces	5	Removable terminal block (RTB)
3	DIN rail locking screw (orange)		

### Install the Module

To install the module on the DIN rail (Allen-Bradley® part number 199-DR1; 46277-3; EN50022), proceed as follows.

---



**ATTENTION:** This product is grounded through the DIN rail to chassis ground. Use zinc plated chromate-passivated steel DIN rail to assure proper grounding. The use of other DIN rail materials (for example, aluminum or plastic) that can corrode, oxidize, or are poor conductors, can result in improper or intermittent grounding. Secure DIN rail to mounting surface approximately every 200 mm (7.8 in.) and use end-anchors appropriately. Be sure to ground the DIN rail properly. Refer to Industrial Automation Wiring and Grounding Guidelines, Rockwell Automation publication [1770-4.1](#), for more information.

---



**WARNING:** When used in a Class I, Division 2, hazardous location, this equipment must be mounted in a suitable enclosure with proper wiring method that complies with the governing electrical codes.

---



**ATTENTION:** If you insert or remove the module while backplane power is on, an electrical arc can occur. This could cause an explosion in hazardous location installations.

Be sure that power is removed or the area is nonhazardous before proceeding. Repeated electrical arcing causes excessive wear to contacts on both the module and its mating connector. Worn contacts may create electrical resistance that can affect module operation.

---

1. Position the module vertically above the DIN rail.
2. Engage the interlocking pieces with the unit on the left.
3. Press down firmly to install the module on the DIN rail.  
The locking mechanism locks the module to the DIN rail.



## Remove the Module

To remove a 1734-FPD or 1734-FPDK module, you must first remove any I/O module installed in the base to the right. To remove the 1734-FPD or 1734-FPDK module from the DIN rail, proceed as follows:

1. Pull up on the RTB removal handle to remove the terminal block.

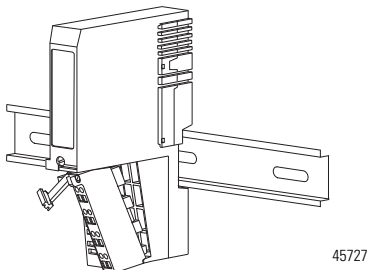

2. Use a small-bladed screwdriver to rotate the DIN rail locking screw to a vertical position. This releases the locking mechanism.
3. Lift straight up to remove.

## Replace the Module

To install a replacement module in an existing system, proceed as follows:



**WARNING:** When you connect or disconnect the removable terminal block (RTB) with field-side power applied, an electrical arc can occur. This can cause an explosion in hazardous location installations.

Be sure that power is removed or the area is nonhazardous before proceeding

1. Position the module vertically above the DIN rail.
2. Slide the module down to engage the interlocking sides pieces to the adjacent modules on both the left and right sides.
3. Press down firmly to install the module on the DIN rail. The module locking mechanism snaps into place.

## Wire the Module

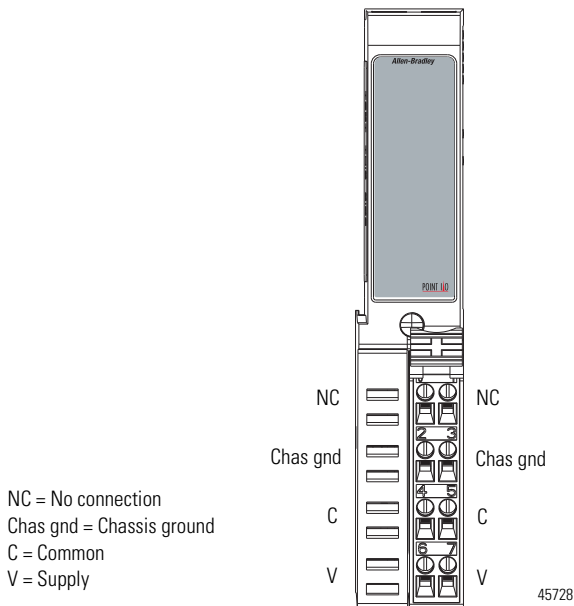

**ATTENTION:** If you connect or disconnect wiring while the field-side power is on, an electrical arc can occur. This could cause an explosion in hazardous location installations. Be sure that power is removed or the area is nonhazardous before proceeding.

### 12/24V DC Wiring

V = 12/24V DC

C = Common

Chas gnd = Chassis ground

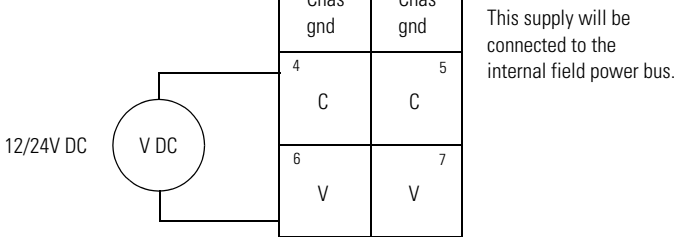

Connect	Terminal
+V DC	6
-V DC	4
Chas gnd	2

12/24V DC becomes the internal field power bus for modules to the right.

## 12 POINT I/O Field Potential Distributor Modules

### 120/240V AC Wiring

L2/N = Neutral

L1 = 120/240V AC

Chas gnd = Chassis ground

120/240V AC

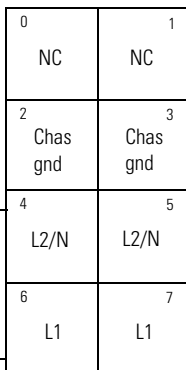
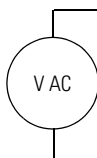

This supply will be connected to the internal field power bus.

Connect	Terminal
L1	6
L2/N	4
Chas gnd	2

120/240V AC becomes the internal power bus for modules to the right.

## Specifications

### General Specifications

Attribute	Value
Terminal base screw torque	0.6 Nm (7 lb-in.)
Module location	Between I/O modules in 1734 system Breaks power bus
Indicators	None
POINTBus current	Pass through
Power consumption	None
Power dissipation	None
Thermal dissipation	None
Isolation voltage (continuous-voltage withstand rating)	50 V continuous Tested @ 2600V DC for 60 s
Input voltage rating	12V DC, 24V DC nom 10...28.8V DC range 120V AC, 240V AC nom
Input current, max	10 A
Field power bus supply voltage	264V AC max, 12V DC, 24V DC, 10...28.8V DC range 120V AC, 240V AC, 50/60 Hz
Field power bus supply current, max	10 A
Dimensions (HxWxD), approx.	76.2 x 25.4 x 133.4 mm (3.00 x 1.00 x 5.25 in.)
Weight	0.12 kg (0.27 lb)
Wiring category <sup>(1) (2)</sup>	1 – on power ports
Wire size	0.25...2.5 mm <sup>2</sup> (22...14 AWG) solid or stranded copper wire rated at 75 °C (167 °F) or greater 1.2 mm (3/64 in.) insulation max
Enclosure type rating	None (open-style)
North American temp code	T4A
ATEX temperature code	T4

<sup>(1)</sup> Use this conductor category information for planning conductor routing as described in Industrial Automation Wiring and Grounding Guidelines, publication [1770-4.1](#).

<sup>(2)</sup> Use this Conductor Category information for planning conductor routing as described in the appropriate System Level Installation Manual.

## 14 POINT I/O Field Potential Distributor Modules



At the end of its life, this equipment should be collected separately from any unsorted municipal waste.

### Environmental Specifications

Attribute	Value
Temperature, operating	IEC 60068-2-1 (Test Ad, Operating Cold), IEC 60068-2-2 (Test Bd, Operating Dry Heat), IEC 60068-2-14 (Test Nb, Operating Thermal Shock): -20...55 °C (-4...131 °F)
Temperature, surrounding air, max.	55 °C (131 °F)
Temperature, nonoperating	IEC60068-2-1 (Test Ab, Unpackaged Nonoperating Cold) IEC60068-2-2 (Test Bb, Unpackaged Nonoperating Dry Heat) IEC60068-2-14 (Test Na, Unpackaged Nonoperating Thermal Shock): -40...85 °C (-40...185 °F)
Relative humidity	IEC60068-2-30 (Test Db, Unpackaged Nonoperating Damp Heat): 5...95% noncondensing
Vibration	IEC 60068-2-6 (Test Fc, Operating): 5 g @ 10...500 Hz
Shock, operating	IEC60068-2-27 (Test Ea, Unpackaged Shock): 30 g
Shock, nonoperating	IEC60068-2-27 (Test Ea, Unpackaged Shock): 50 g
Emissions	IEC 61000-6-4
ESD immunity	IEC61000-4-2: 6 kV contact discharges 8 kV air discharges
Radiated RF immunity	IEC 61000-4-3: 10 V/m with 1 kHz sine-wave 80% AM from 30...2000 MHz 10 V/m with 200Hz 50% pulse 100% AM @ 900 MHz 10 V/m with 200 Hz 50% pulse 100% AM @ 1890 MHz 3V/m with 1 kHz sine-wave 80% AM from 2000...2700 MHz
EFT/B immunity	IEC 61000-4-4: ±4 kV @ 2.5 kHz on power ports
Surge transient immunity	IEC 61000-4-5: ±1 kV line-line (DM) and ±2 kV line-earth (CM) on power ports
Conducted RF immunity	IEC61000-4-6: 10V rms with 1 kHz sine-wave 80% AM @ 150 kHz...80 MHz

## Certifications

<b>Certification (when product is marked)<sup>(1)</sup></b>	<b>Value</b>
c-UL-us	UL-listed Industrial Control Equipment, certified for U.S. and Canada. See UL File E65584.  UL-listed for Class I, Division 2, Group A,B,C,D Hazardous Locations, certified for U.S. and Canada. See UL File E194810.
CE	European Union 2014/30/EU EMC Directive, compliant with: EN 61326-1; Meas./Control/Lab., Industrial Requirements EN 61000-6-2; Industrial Immunity EN 61000-6-4; Industrial Emissions EN 61131-2; Programmable Controllers (Cl. 8, Zone A & B)  European Union 2014/35/EU LVD, compliant with: EN 61131-2; Programmable Controllers (Clause 11)  European Union 2011/65/EU RoHS, compliant with: EN 50581; Technical Documentation
RCM	Australian Radiocommunications Act, compliant with: AS/NZS CISPR11; Industrial Emissions
Ex 	European Union 2014/34/EU ATEX Directive, compliant with: EN 60079-0:2012+A11: 2013; General Requirements EN 60079-15: 2010; Potentially Explosive Atmospheres, Protection “n” II 3 G Ex nA IIC T4 Gc DEMKO 04 ATEX 0330347X When used at or below 120V AC
KC	Korean Registration of Broadcasting and Communications Equipment, compliant with: Article 58-2 of Radio Waves Act, Clause 3
EAC	Russian Customs Union TR CU 020/2011 EMC Technical Regulation Russian Customs Union TR CU 004/2011 LV Technical Regulation

<sup>(1)</sup> See the Product Certification link at <http://www.rockwellautomation.com/global/certification/overview.page> for Declaration of Conformity, Certificates, and other certification details.

## Rockwell Automation Support

Rockwell Automation provides technical information on the Web to assist you in using its products. At <http://www.rockwellautomation.com/support/>, you can find technical manuals, a knowledge base of FAQs, technical and application notes, sample code and links to software service packs, and a MySupport feature that you can customize to make the best use of these tools.

For an additional level of technical phone support for installation, configuration and troubleshooting, we offer TechConnect support programs. For more information, contact your local distributor or Rockwell Automation representative, or visit <http://www.rockwellautomation.com/support/>.

## Installation Assistance

If you experience a problem within the first 24 hours of installation, please review the information that's contained in this manual. You can also contact a special Customer Support number for initial help in getting your product up and running.

United States or Canada	1.440.646.3434
Outside United States or Canada	Use the <a href="#">Worldwide Locator</a> at <a href="http://www.rockwellautomation.com/support/americas/phone_en.html">http://www.rockwellautomation.com/support/americas/phone_en.html</a> , or contact your local Rockwell Automation representative.

## New Product Satisfaction Return

Rockwell Automation tests all of its products to ensure that they are fully operational when shipped from the manufacturing facility. However, if your product is not functioning and needs to be returned, follow these procedures.

United States	Contact your distributor. You must provide a Customer Support case number (call the phone number above to obtain one) to your distributor to complete the return process.
Outside United States	Please contact your local Rockwell Automation representative for the return procedure.

## Documentation Feedback

Your comments will help us serve your documentation needs better. If you have any suggestions on how to improve this document, complete this form, publication [RA-DU002](#), available at <http://www.rockwellautomation.com/literature/>.

Rockwell Automation maintains current product environmental information on its website at <http://www.rockwellautomation.com/rockwellautomation/about-us/sustainability-ethics/product-environmental-compliance-page>.

Allen-Bradley, POINT I/O, Rockwell Automation, Rockwell Software, and TechConnect are trademarks of Rockwell Automation, Inc. Trademarks not belonging to Rockwell Automation are property of their respective companies.

Rockwell Otomasyon Ticaret A.Ş., Kar Plaza İş Merkezi E Blok Kat:6 34752 İçerenköy, İstanbul, Tel: +90 (216) 5698400  
[www.rockwellautomation.com](http://www.rockwellautomation.com)

### Power, Control and Information Solutions Headquarters

Americas: Rockwell Automation, 1201 South Second Street, Milwaukee, WI 53204-2496 USA, Tel: (1) 414.382.2000, Fax: (1) 414.382.4444  
Europe/Middle East/Africa: Rockwell Automation NV, Pegasus Park, De Kleedaan 12a, 1831 Diegem, Belgium, Tel: (32) 2 663 0600, Fax: (32) 2 663 0640  
Asia Pacific: Rockwell Automation, Level 14, Core F, Cyberport 3, 100 Cyberport Road, Hong Kong, Tel: (852) 2887 4788, Fax: (852) 2508 1846

Publication 1734-IN059G-EN-P - December 2018

PN-519193