

| | | | |
|------------------------------------|-------------------|-----------------|----------|
| F3X34 Series Router User Manual | Documentation No. | Product Version | Page |
| | | | |
| | Product Name: | | Total:90 |

F3X34 Series Router User Manual

The user manual is suitable for the following model:

| Model | Product Type |
|-------|--------------------------|
| F3134 | GPRS WIFI ROUTER |
| F3234 | CDMA WIFI ROUTER |
| F3334 | EDGE WIFI ROUTER |
| F3434 | WCDMA WIFI ROUTER |
| F3534 | TD-SCDMA WIFI ROUTER |
| F3634 | EVDO WIFI ROUTER |
| F3734 | LTE&TD-SCDMA WIFI ROUTER |
| F3834 | LTE&WCDMA WIFI ROUTER |
| F3A34 | LTE&EVDO WIFI ROUTER |



Xiamen Four-Faith Communication Technology Co., Ltd.

Add: J1-J3,3rd Floor,No.44,GuanRI Road,SoftWare

Park,XiaMen,China Zip Code:361008

Tel: +86 592-6300326 , 6300325, 6300324

Fax:+86 592-5912735

<http://www.fourfaith.co>



Files Revised Record

| Date | Version | Remark | Author |
|------------|---------|---|---------|
| 2012-05-16 | V1.00 | Initial Draft | ZYL |
| 2012-9-17 | V1.01 | Add GRE and Applications | PF |
| 2012-11-1 | V1.02 | Add Packet Filter | PF |
| 2013-3-5 | V1.03 | Modify part of the description of the error | ZYL, PF |
| | | | |

Copyright Notice

All contents in the files are protected by copyright law, and all copyrights are reserved by Xiamen Four-Faith Communication Technology Co., Ltd. Without written permission, all commercial use of the files from Four-Faith are forbidden, such as copy, distribute, reproduce the files, etc., but non-commercial purpose, downloaded or printed by individual (all files shall be not revised, and the copyright and other proprietorship notice shall be reserved) are welcome.

Trademark Notice

Four-Faith、四信、、、 are all registered trademarks of Xiamen Four-Faith Communication Technology Co., Ltd., illegal use of the name of Four-Faith, trademarks and other marks of Four-Faith is forbidden, unless written permission is authorized in advance.



Contents

| | |
|--|----|
| Chapter 1 Brief Introduction of Product..... | 7 |
| 1.1 General..... | 7 |
| 1.2 Features and Benefits..... | 7 |
| 1.3 Working Principle..... | 8 |
| 1.4 Specifications..... | 9 |
| Chapter 2 Installation Introduction..... | 13 |
| 2.1 General..... | 13 |
| 2.2 Encasement List..... | 13 |
| 2.3 Installation and Cable Connection..... | 13 |
| 2.4 Power..... | 15 |
| 2.5 Indicator Lights Introduction..... | 15 |
| 2.6 Reset Button Introduction..... | 16 |
| Chapter 3 Configuration and Management..... | 17 |
| 3.1 Configuration Connection..... | 17 |
| 3.2 Access the Configuration Web Page..... | 17 |
| 3.3 Management and configuration..... | 19 |
| 3.3.1 Setting..... | 19 |
| 3.3.1.1 Basic Setting..... | 19 |
| 3.3.1.2 Dynamic DNS..... | 26 |
| 3.3.1.3 Clone MAC Address..... | 27 |
| 3.3.1.4 Advanced Router..... | 28 |
| 3.3.1.5 VLANs..... | 29 |
| 3.3.1.6 Networking..... | 30 |
| 3.3.2 Wireless..... | 33 |
| 3.3.2.1 Basic Settings..... | 33 |
| 3.3.2.2 Wireless Security..... | 35 |
| 3.3.2.3 Wireless MAC Filter..... | 38 |
| 3.3.2.4 Advance Settings..... | 39 |
| 3.3.2.5 WDS..... | 43 |
| 3.3.3 Services..... | 44 |
| 3.3.3.1 Services..... | 44 |
| 3.3.3.2 PPPoE Server..... | 47 |
| 3.3.4 VPN..... | 49 |
| 3.3.4.1 PPTP..... | 49 |
| 3.3.4.2 L2TP..... | 50 |
| 3.3.4.3 OPENVPN..... | 52 |
| 3.3.4.4 IPSEC..... | 56 |
| 3.3.4.5 GRE..... | 58 |
| 3.3.5 Security..... | 60 |
| 3.3.5.1 Firewall..... | 60 |

| | | |
|-----------|--------------------------|----|
| 3.3.5.2 | VPN Passthrough..... | 62 |
| 3.3.6 | Access Restrictions..... | 63 |
| 3.3.6.1 | WAN Access..... | 63 |
| 3.3.6.2 | Packet Filter..... | 66 |
| 3.3.7 | NAT..... | 67 |
| 3.3.7.1 | Port Forwarding..... | 67 |
| 3.3.7.2 | Port Range Forward..... | 67 |
| 3.3.7.3 | Port Triggering..... | 68 |
| 3.3.7.4 | DMZ..... | 69 |
| 3.3.8 | QoS Setting..... | 69 |
| 3.3.8.1 | Basic..... | 69 |
| 3.3.8.2 | Classify..... | 70 |
| 3.3.9 | Applications..... | 70 |
| 3.3.9.1 | Serial Applications..... | 70 |
| 3.3.10 | Administration..... | 72 |
| 3.3.10.1 | Management..... | 72 |
| 3.3.10.2 | Keep Alive..... | 74 |
| 3.3.10.3 | Commands..... | 74 |
| 3.3.10.4 | Factory Defaults..... | 74 |
| 3.3.10.5 | Firmware Upgrade..... | 75 |
| 3.3.10.6 | Backup..... | 75 |
| 3.3.11 | Status..... | 76 |
| 3.3.11.1 | Router..... | 76 |
| 3.3.11.2 | WAN..... | 78 |
| 3.3.11.3 | LAN..... | 80 |
| 3.3.11.4 | Wireless..... | 83 |
| 3.3.11.5 | Bandwidth..... | 84 |
| 3.3.11.6 | Sys-Info..... | 86 |
| Chapter 4 | Appendix..... | 89 |

Chapter 1 Brief Introduction of Product

1.1 General

F3X34 series ROUTER is a kind of cellular terminal device that provides data transfer function by public cellular network.

It adopts high-powered industrial 32-bits CPU and embedded real time operating system. It supports RS232 (or RS485/RS422), Ethernet and WIFI port that can conveniently and transparently connect one device to a cellular network, allowing you to connect to your existing serial, Ethernet and WIFI devices with only basic configuration.

It has been widely used on M2M fields, such as intelligent transportation, smart grid, industrial automation, telemetry, finance, POS, water supply, environment protection, post, weather, and so on.

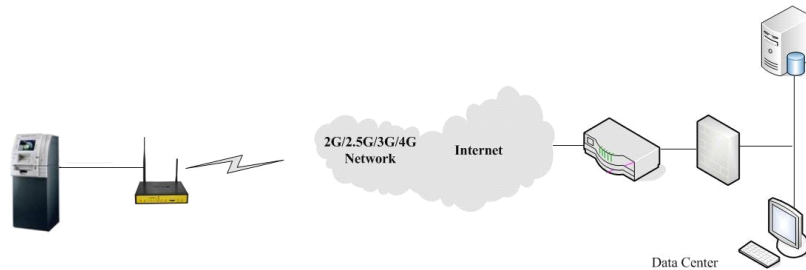

1.2 Features and Benefits

Design for Industrial Application

- ◆ High-powered industrial cellular module
- ◆ High-powered industrial 32bits CPU
- ◆ Support low-consumption mode, including sleep mode, scheduled online/offline mode, scheduled power-on/power-off mode(optional)
- ◆ Housing: iron, providing IP30 protection.
- ◆ Power range: DC 5~35V

Stability and Reliability

- ◆ Support hardware and software WDT
- ◆ Support auto recovery mechanism, including online detect, auto redial when offline to make router always online
- ◆ Ethernet port: 1.5KV magnetic isolation protection
- ◆ RS232/RS485/RS422 port: 15KV ESD protection
- ◆ SIM/UIM port: 15KV ESD protection
- ◆ Power port: reverse-voltage and overvoltage protection

- ◆ Antenna port: lightning protection(optional)

Standard and Convenience

- ◆ Support standard RS232(or RS485/RS422), Ethernet and WIFI port that can connect to serial, Ethernet and WIFI devices directly
- ◆ Support standard WAN port and PPPOE protocol that can connect to ADSL directly
- ◆ Support intellectual mode, enter into communication state automatically when powered
- ◆ Provide management software for remote management
- ◆ Support several work modes
- ◆ Convenient configuration and maintenance interface (WEB or CLI)

High-performance

- ◆ Support multiple WAN access methods, including static ip, DHCP, L2TP, PPTP,PPPOE,3G/HSPA/4G.
- ◆ Support double link backup between cellular and WAN(PPPOE, ADSL) (optional)
- ◆ Support VPN client(PPTP, L2TP, OPENVPN, IPSEC and GRE)(only for VPN version)
- ◆ Support VPN server(PPTP, L2TP, OPENVPN, IPSEC and GRE)(only for VPN version)
- ◆ Support local and remote firmware upgrade,import and export configure file.
- ◆ Support NTP, RTC embedded.
- ◆ Support multiple DDNS provider service.
- ◆ Support VLANs, MAC Address clone, PPPoE Server
- ◆ WIFI support 802.11b/g/n. support AP, client, Adhoc, Repeater, Repeater Bridge and WDS(optional) mode.
- ◆ WIFI support WEP,WPA,WPA2 encryption,Support RADIUS authentication and MAC address filter.
- ◆ Support multi online trigger ways, including SMS, ring and data. Support link disconnection when timeout
- ◆ Support APN/VPDN
- ◆ Support DHCP server and client, firewall, NAT, DMZ host , URL block, QoS, ttraff,statistics, real time link speed statistics etc.
- ◆ Full protocol support , such as TCP/IP, UDP, ICMP, SMTP(optional), HTTP, POP3(optional), OICQ(optional), TELNET, FTP(optional), SNMP, SSHD, etc.
- ◆ Schedule Reboot, Schedule Online and Offline,etc.

1.3 Working Principle

The principle chart of the router is as following:

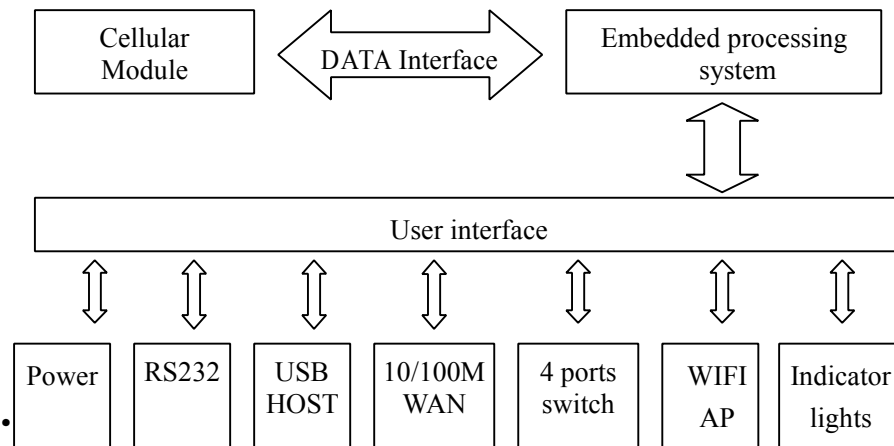

1.4 Specifications

Cellular Specification

| Standard and Band | Bandwidth | TX power | RX sensitivity |
|--|---|--|----------------|
| F3134 GPRS WIFI ROUTER | | | |
| EGSM900/GSM1800MHz, GSM850/900/1800/1900MHz (optional) Compliant to GSM phase 2/2+ GPRS class 10, class 12(optional) | 85.6Kbps | GSM850/900: <33dBm GSM1800/1900: <30dBm | <-107 dBm |
| F3234 CDMA WIFI ROUTER | | | |
| CDMA2000 1xRTT 800MHz 800/1900MHz(optional) 450MHz(optional) | 153.6Kbps | <30dBm | <-104 dBm |
| F3334 EDGE WIFI ROUTER | | | |
| GSM850/900/1800/1900MHz GPRS/EDGE Class 12 | 236.8Kbps | GSM850/900: <33dBm GSM1800/1900: <30dBm | <-106 dBm |
| F3434 WCDMA&HSDPA&HSUPA WIFI ROUTER | | | |
| UMTS/WCDMA/HSDPA/HSUPA /HSPA+ 850/1900/2100MHz 850/900/1900/2100MHz(optional) GSM850/900/1800/1900MHz GPRS/EDGE CLASS 12 | HSUPA:5.76Mbps (Upload speed) HSDPA:7.2Mbps (Download speed) UMTS:384Kbps (DL/UL) | <24dBm | <-109dBm |

| | | | |
|---|---|--------|-----------|
| | HSPA+: 21 Mbps (Download speed) 5.76Mbps (Upload speed) | | |
| F3534 TD-SCDMA WIFI ROUTER | | | |
| TD-SCDMA/HSDPA/HSUPA 1880-1920/2010-2025MHz GSM850/900/1800/1900MHz GPRS/EDGE CLASS 12 | Download speed:2.8Mbps upload speed:2.2Mbps | <24dBm | <-108dBm |
| F3634 CDMA2000 1X EVDO WIFI ROUTER | | | |
| CDMA2000 1X EVDO Rev A 800MHz,800/1900MHz(optional) 450MHz (optional) CDMA2000 1X RTT, IS-95 A/B | Download speed:3.1Mbps, upload speed:1.8Mbps;Rev B(optional): Download speed:14.7Mbps, upload speed:5.4Mbps | <23dBm | <-104dBm |
| F3734 LTE/TD-SCDMA WIFI ROUTER | | | |
| LTE TDD 2600/2300MHz. DC-HSPA+/HSPA+/HSUPA/HSD PA/UMTS 2100/900MHz EDGE/GPRS/GSM 850/900/1800/1900MHz | LTE(Download speed:68Mbps, upload speed:17Mbps) HSUPA:5.76Mbps(upl oad speed) HSDPA:14.4Mbps(Do wnload speed) HSPA+: 28Mbps(Download speed) | <24dBm | <-106dBm |
| F3834 LTE/WCDMA WIFI ROUTER | | | |
| LTE/FDD 2600/2100/1800/900/800MHz, 700/1700/2100MHz(optional) HSPA+/HSDPA/HSUPA/WCDMA /UMTS900/2100MHz, 800/850/1900/2100MHz(optional) EDGE/GPRS/GSM 900/1800/1900MHz GPRS CLASS 10 EDGE CLASS 12 | LTE(DL:100Mbps,UL :50Mbps) HSUPA:5.76Mbps(Upl oad speed) HSDPA:7.2Mbps(Do wnload speed) UMTS:384Kbps (DL/UL) HSPA+: 21Mbps(Download speed) 5.76Mbps(Upload speed) | <32dBm | <-93.3dBm |

| F3A34 LTE&EVDO WIFI ROUTER | | | |
|---|--|--------|-----------|
| LTE 700MHz CDMA 1XRTT/EV 800/1900MHz | LTE(DL:100Mbps, UL:50Mbps)/ CDMA2000 1X EVDO Rev A (DL:3.1Mbps, UL:1.8Mbps / | <32dBm | <-93.3dBm |

WIFI Specification

| Item | Content |
|----------------|---|
| Standard | IEEE802.11b/g/n |
| Bandwidth | IEEE802.11b/g: 54Mbps (max) IEEE802.11n: 150Mbps (max) |
| Security | WEP, WPA, WPA2, etc. WPS (optional) |
| TX power | 21.5dBm (11g), 26dBm (11b) |
| RX sensitivity | <-72dBm@54Mbps |

Hardware System

| Item | Content |
|-------|-------------------------|
| CPU | Industrial 32bits CPU |
| FLASH | 8MB(Extendable to 64MB) |
| SDRAM | 64MB |

Interface Type

| Item | Content |
|-----------|--|
| WAN | 1 10/100 Mbps WAN port(RJ45), auto MDI/MDIX, 1.5KV magnetic isolation protection |
| LAN | 4 10/100 Mbps Ethernet ports(RJ45), auto MDI/MDIX, 1.5KV magnetic isolation protection |
| Serial | 1 RS232(or RS485/RS422) port, 15KV ESD protection Data bits: 5, 6, 7, 8 Stop bits: 1, 1.5(optional), 2 Parity: none, even, odd, space(optional), mark(optional) Baud rate: 2400~115200 bps |
| Indicator | "Power", "System", "Online", "Alarm", " Local Network ", "WAN", "WIFI", "Signal Strength" |
| Antenna | Cellular: Standard SMA female interface, 50 ohm, lightning protection(optional) WIFI: Standard SMA male interface, 50 ohm, lightning protection(optional) |
| SIM/UIM | Standard 3V/1.8V user card interface, 15KV ESD protection |

| | |
|-------|---|
| Power | Standard 3-PIN power jack, reverse-voltage and overvoltage protection |
| Reset | Restore the router to its original factory default settings |
| USB | Standard A type USB host interface (reserved) |

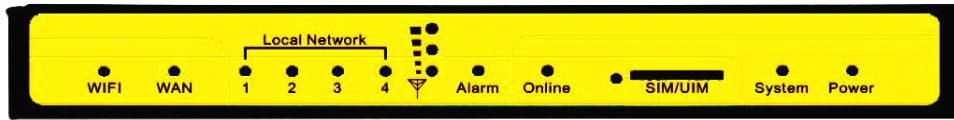

Power Input

| Item | Content |
|----------------|--------------|
| Standard Power | DC 12V/1.5A |
| Power Range | DC 5~35V |
| Consumption | <450mA (12V) |

Physical Characteristics

| Item | Content |
|------------|---------------------------------|
| Housing | Iron, providing IP30 protection |
| Dimensions | 206x135x28 mm |
| Weight | 790g |

Environmental Limits

| Item | Content |
|-----------------------|------------------------|
| Operating Temperature | -35~+75°C (-31~+167°F) |
| Storage Temperature | -40~+85°C (-40~+185°F) |
| Operating Humidity | 95% (Non-condensing) |

Chapter 2 Installation Introduction

2.1 General

The router must be installed correctly to make it work properly.

Warning: Forbid to install the router when powered!

2.2 Encasement List

| Name | Quantity | Remark |
|-----------------------------|----------|----------|
| Router host | 1 | |
| Cellular antenna (Male SMA) | 1 | |
| WIFI antenna (Female SMA) | 1 | |
| Network cable | 1 | |
| Console cable | 1 | optional |
| Power adapter | 1 | |
| Manual CD | 1 | |
| Certification card | 1 | |
| Maintenance card | 1 | |

2.3 Installation and Cable Connection

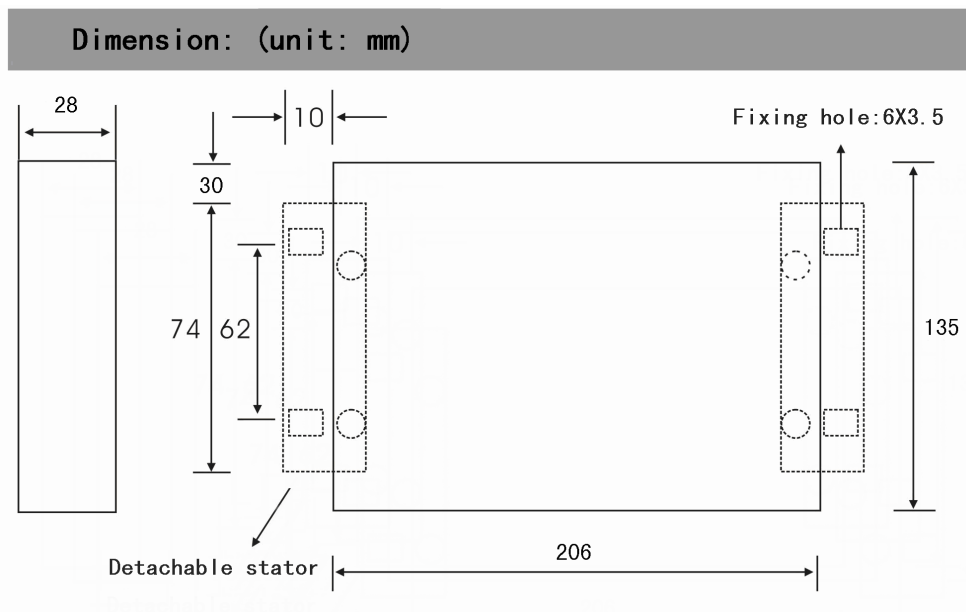

Installation of SIM/UIM card:

Firstly power off the router, and press the out button of the SIM/UIM card outlet with a needle object. Then the SIM/UIM card sheath will flick out at once. Put SIM/UIM card into the card sheath (Pay attention to put the side which has metal point outside), and insert card sheath back to the SIM/UIM card outlet.

Warning: Forbid to install SIM/UIM card when powered!

Installation of antenna:

Screw the SMA male pin of the cellular antenna to the female SMA interface of the router with sign “ANT”.

Screw the SMA female pin of the WIFI antenna to the male SMA interface of the router with sign “WIFI”.

Warning: The cellular antenna and the WIFI antenna can not be connected wrongly. And the antennas must be screwed tightly, or the signal quality of antenna will be influenced!

Installation of cable:

Insert one end of the network cable into the switch interface with sign “Local Network”, and insert the other end into the Ethernet interface of user’s device. The signal connection of network direct cable is as follows:

| RJ45-1 | RJ45-2 |
|--------|--------|
| 1 | 1 |
| 2 | 2 |
| 3 | 3 |
| 4 | 4 |
| 5 | 5 |
| 6 | 6 |
| 7 | 7 |
| 8 | 8 |

Insert the RJ45 end of the console cable into the RJ45 outlet with sign “console”, and insert the DB9F end of the console cable into the RS232 serial interface of user’s device.

The signal connection of the console cable is as follows:

| RJ45 | DB9F |
|------|------|
| 1 | 8 |
| 2 | 6 |
| 3 | 2 |
| 4 | 1 |
| 5 | 5 |
| 6 | 3 |
| 7 | 4 |
| 8 | 7 |

The signal definition of the DB9F serial communication interface is as follows:

| Pin | RS232 signal name | The direction for Router |
|-----|-------------------|--------------------------|
| 1 | DCD | output |
| 2 | RXD | output |
| 3 | TXD | input |
| 4 | DTR | input |
| 5 | GND | |
| 6 | DSR | output |
| 7 | RTS | input |
| 8 | CTS | output |

2.4 Power

The power range of the router is DC 5~35V.

Warning: When we use other power, we should make sure that the power can supply power above 7W.

We recommend user to use the standard DC 12V/1.5A power.

2.5 Indicator Lights Introduction

The router provides following indicator lights: “Power”, “System”, “Online”, “Alarm”, “Local Network”, “WAN”, “WIFI”, “Signal Strength”.

| Indicator Light | State | Introduction |
|-----------------|------------|---|
| Power | ON | Router is powered on |
| | OFF | Router is powered off |
| System | BLINK | System works properly |
| | OFF | System does not work |
| Online | ON | Router has logged on network |
| | OFF | Router hasn't logged on network |
| Alarm | ON | SIM/UIM card does not work or the signal of the antenna is weak |
| | OFF | Router has no alarm |
| Local Network | OFF | The corresponding interface of switch is not connected |
| | ON / BLINK | The corresponding interface of switch is connected /Communicating |
| WAN | OFF | The interface of WAN is not connected |

| | | |
|--------------------|--------------------|--|
| | ON / BLINK | The interface of WAN is connected /Communicating |
| WIFI | OFF | WIFI is not active |
| | ON | WIFI is active |
| Signal Strength | One Light ON | Signal strength is weak |
| | Two Lights ON | Signal strength is medium |
| | Three Lights ON | Signal strength is good |

2.6 Reset Button Introduction

The router has a “Reset” button to restore it to its original factory default settings. When user press the “Reset” button for up to 15s, the router will restore to its original factory default settings and restart automatically.

Chapter 3 Configuration and Management

This chapter describes how to configure and manage the router.

3.1 Configuration Connection

Before configuration, you should connect the router and your configuration PC with the supplied network cable. Plug the cable's one end into the Local Network port of the router, and another end into your configure PC's Ethernet port. The connection diagram is as following:

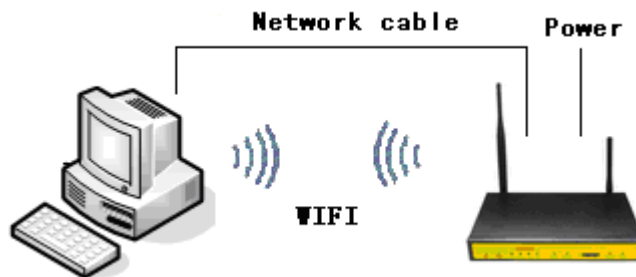

Please modify the IP address of PC as the same network segment address of the router, for instance, 192.168.1.9. Modify the mask code of PC as 255.255.255.0 and set the default gateway of PC as the router's IP address (192.168.1.1).

3.2 Access the Configuration Web Page

The chapter is to present main functions of each page. Users visit page tool via web browser after connect users' PC to the router. There are eleven main pages: Setting, Wireless, Service, VPN, Security, Access Restrictions, NAT, QoS Setting, Applications, Management and Status. Users enable to browse slave pages by click one main page..

Users can open IE or other explorers and enter the router's default IP address of 192.168.1.1 on address bar, then press the botton of Enter to visit page Web management tool of the router. The users login in the web page at the first name, there will display a page shows as blow to tip users to modify the default user name and password of the router. Users have to click "change password" to make it work if they modify user name and password.

Router Management

Your Router is currently not protected and uses an unsafe default username and password combination, please change it using the following dialog!

Router Password

Router Username:

Router Password:

Re-enter to confirm:

After access to the information main page



Wireless Mobile Router
Firmware: F3x34 v1.0 (Sep 11 2012 19:55:19) std
 Time: 17:23:01 up 0 min, load average: 0.00, 0.00, 0.00
 WAN IP: 0.0.0.0

Menu

- Setup
- Wireless
- Services
- VPN
- Security
- Access Restrictions
- NAT
- QoS Setting
- Applications
- Administration
- Status

System Information

| Router | |
|--------------|-------------------|
| Router Name | Four-Faith |
| Router Model | Four-Faith Router |
| LAN MAC | 00:0C:43:30:52:77 |
| WAN MAC | 00:0C:43:30:52:78 |
| Wireless MAC | 00:0C:43:30:52:79 |
| WAN IP | 0.0.0.0 |
| LAN IP | 192.168.1.1 |

| Services | |
|-------------|----------|
| DHCP Server | Enabled |
| ff-radauth | Disabled |
| USB Support | Enabled |

| Memory | |
|-----------------|-------------------|
| Total Available | 59.2 MB / 64.0 MB |
| Free | 41.2 MB / 59.2 MB |
| Used | 18.0 MB / 59.2 MB |
| Buffers | 1.7 MB / 18.0 MB |
| Cached | 5.5 MB / 18.0 MB |
| Active | 0.9 MB / 18.0 MB |
| Inactive | 1.2 MB / 18.0 MB |

| Wireless | |
|----------|--------------|
| Radio | Radio is On |
| Mode | AP |
| Network | Mixed |
| SSID | four-faith |
| Channel | 6 (2437 MHz) |
| TX Power | 71 mW |
| Rate | 72 Mb/s |

| Wireless Packet Info | |
|----------------------|----------------|
| Received (RX) | 3 OK, no error |
| Transmitted (TX) | 9 OK, no error |

Wireless Clients

| MAC Address | Interface | Uptime | TX Rate | RX Rate | Signal | Noise | SNR | Signal Quality |
|-------------|-----------|--------|---------|---------|--------|-------|-----|----------------|
| - None - | | | | | | | | |

DHCP Clients

| Host Name | IP Address | MAC Address | Client Lease Time |
|-----------|------------|-------------|-------------------|
| - None - | | | |

Users need to input user name and password if it is their first time to login.



Input correct user name and password to visit relevant menu page. Default user name is admin, password is admin. (available to modify user name and password on management page, then click submit)

3.3 Management and configuration

3.3.1 Setting

The Setup screen is the first screen users will see when accessing the router. Most users will be able to configure the router and get it work properly using only the settings on this screen. Some Internet Service Providers (ISPs) will require users to enter specific information, such as User Name, Password, IP Address, Default Gateway Address, or DNS IP Address. These information can be obtained from your ISP, if required.

3.3.1.1 Basic Setting

WAN Connection Type

Seven Ways: Disabled, Static IP, Automatic Configuration-DHCP, PPPOE, PPTP, L2TP, 3G/UNMTS/4G/LTE

Disabled

Xiamen Four-Faith Communication Technology Co.,Ltd.

Page 19 of 90

Add: J1-J3,3rdFloor,No.44,GuanRiRoad,SoftWare Park,XiaMen .361008.China

http: //www.fourfaith.com Tel: +86 592-6300326 6300325 6300324 Fax: +86 592-5912735

Connection Type

Forbid the setting of WAN port connection type

Static IP

Connection Type

WAN IP Address ...

Subnet Mask ...

Gateway ...

Static DNS 1 ...

Static DNS 2 ...

Static DNS 3 ...

WAN IP Address: Users set IP address by their own or ISP assigns

Subnet Mask: Users set subnet mask by their own or ISP assigns

Gateway: Users set gateway by their own or ISP assigns

Static DNS1/DNS2/DNS3: Users set static DNS by their own or ISP assigns

Automatic Configuration-DHCP

Connection Type

IP address of WAN port gets automatic via DHCP

PPPOE

Connection Type

User Name

Password Unmask

Service Name

PPP Compression (MPPC) Enable Disable

T-Home VDSL VLAN 7/8 Tagging Enable Disable

MPPE Encryption

Single Line Multi Link

User Name: login the Internet

Password: login the Internet

Service Name: provided by ISP server, if not, keep it null

PPP Compression (MPPC): provides a method to negotiation and use of compressed in PPP encapsulation link protocol

T-Home VDSL VLAN 7/8 Tagging: enable to support the front of the modem is vdsl

MPPE Encryption: Microsoft point to point encryption. It is used to encrypt the point-to-point link connection agreement of the encrypted data packet

Single Line Multi Link: enable single line link or disable multi link

PPTP

| | |
|---------------------------|---|
| Connection Type | <input type="text" value="PPTP"/> |
| Use DHCP | <input type="radio"/> Yes <input checked="" type="radio"/> No |
| WAN IP Address | <input type="text" value="0"/> . <input type="text" value="0"/> . <input type="text" value="0"/> . <input type="text" value="0"/> |
| Subnet Mask | <input type="text" value="0"/> . <input type="text" value="0"/> . <input type="text" value="0"/> . <input type="text" value="0"/> |
| Gateway | <input type="text" value="0"/> . <input type="text" value="0"/> . <input type="text" value="0"/> . <input type="text" value="0"/> |
| Gateway (PPTP Server) | <input type="text"/> |
| User Name | <input type="text"/> |
| Password | <input type="text"/> <input type="checkbox"/> Unmask |
| PPTP Encryption | <input type="radio"/> Enable <input checked="" type="radio"/> Disable |
| Disable Packet Reordering | <input checked="" type="radio"/> Enable <input type="radio"/> Disable |
| Additional PPTP Options | <input type="text"/> |

Use DHCP: gets IP address, then connect to the server via PPIP

Gateway (PPTP Server): Users set gateway (PPTP server) by their own or ISP assigns

User Name: login the Internet

Password: login the Internet

PPTP Encryption: encrypt PPTP data

Disable Packet Reordering: enable or disable the function

Additional PPTP Options: add extra PPTP functions options for PPTP client, set if needed

L2TP

| | |
|------------------------|---|
| Connection Type | <input type="text" value="L2TP"/> |
| User Name | <input type="text"/> |
| Password | <input type="text"/> <input type="checkbox"/> Unmask |
| Gateway (L2TP Server) | <input type="text"/> |
| Require CHAP | <input checked="" type="radio"/> Yes <input type="radio"/> No |
| Refuse PAP | <input checked="" type="radio"/> Yes <input type="radio"/> No |
| Require Authentication | <input checked="" type="radio"/> Yes <input type="radio"/> No |

User Name: login the Internet

Password: login the Internet

Gateway (L2TP Server): users set L2TP server by their own or ISP assigns

Require CHAP: Yes or No

Refuse PAP: Yes or No

Require Authentication: Yes or No

3G/UMTS/4G/LTE

| | | |
|-----------------|--|---------------------------------|
| Connection Type | <input type="text" value="3G/UMTS/4G/LTE"/> | |
| User Name | <input type="text"/> | |
| Password | <input type="text"/> | <input type="checkbox"/> Unmask |
| Dial String | <input type="text" value="*99***1# (UMTS/3G/3.5G)"/> | |
| APN | <input type="text"/> | |
| PIN | <input type="text"/> | <input type="checkbox"/> Unmask |

User Name: login users' ISP(Internet Service Provider)

Password: login users' ISP

Dial String: dial number of users' ISP

APN: access point name of users' ISP

PIN: PIN code of users' SIM card

Connection type

Connection type

Connection type: Auto, Force 3G, Force 2G, Prefer 3G, Prefer 2G options. If using 4G module, there has 4G network option. Users select different mode depending on their need

Keep Online

| | |
|-----------------------------|--|
| Keep Online Detection | <input type="text" value="Ping"/> |
| Detection Interval | <input type="text" value="60"/> Sec. |
| Primary Detection Server IP | <input type="text" value="166"/> . <input type="text" value="111"/> . <input type="text" value="8"/> . <input type="text" value="238"/> |
| Backup Detection Server IP | <input type="text" value="202"/> . <input type="text" value="119"/> . <input type="text" value="32"/> . <input type="text" value="102"/> |

This function is used to detect whether the Internet connection is active, if users set it and when the router detect the connection is inactive, it will redial to users' ISP immediately to make the connection active.

Detection Method:

None: do not set this function

Ping: Send ping packet to detect the connection, when choose this method, users should also

configure "Detection Interval", "Primary Detection Server IP" and "Backup Detection Server IP" items.

Route: Detect connection with route method, when choose this method, users should also configure "Detection Interval", "Primary Detection Server IP" and "Backup Detection Server IP" items.

PPP: Detect connection with PPP method, when choose this method, users should also configure "Detection Interval" item.

Detection Interval: time interval between two detections, unit is second

Primary Detection Server IP: the server used to response the router's detection packet. This item is only valid for method "Ping" and "Route".

Backup Detection Server IP: the server used to response the router's detection packet. This item is valid for method "Ping" and "Route".

Note: When users choose the "Route" or "Ping" method, it's quite important to make sure that the "Primary Detection Server IP" and "Backup Detection Server IP" are usable and stable, because they have to response the detection packet frequently.

Connection Strategy

Connection Strategy Connect on Demand: Max Idle Time Min.
 Keep Alive: Redial Period Sec.

Connection Strategy: one way is Connect on Demand, that is the link turnoff automatic under the situation that the ready link is idle and idle time meets users' configuration requirement, but it will connect again if users visit Internet. The other way is to keep alive, that is the link enable to dial again when reaching the re-dial period users set after disconnection.

Force reconnect Enable Disable
 Time :

Force reconnect: this option schedules the pppoe or 3G reconnection by killing the pppd daemon and restart it.

Time: needed time to reconnect

STP

STP Enable Disable

STP (Spanning Tree Protocol) can be applied to loop network. Through certain algorithm achieves path redundancy, and loop network cuts to tree-based network without loop in the meantime, thus to avoid the hyperplasia and infinite circulation of a message in the loop network

Optional Configuration

| | |
|-------------|---|
| Router Name | <input type="text" value="Four-Faith"/> |
| Host Name | <input type="text"/> |
| Domain Name | <input type="text"/> |
| MTU | <input type="text" value="Auto"/> <input type="text" value="1500"/> |

Router Name: set router name

Host Name: ISP provides

Domain Name: ISP provides

MTU: auto (1500) and manual (1200-1492 in PPPOE/PPTP/L2TP mode, 576-16320 in other modes)

Router Internal Network Settings

Router IP

| | | | | |
|------------------|----------------------------------|----------------------------------|----------------------------------|--------------------------------|
| Local IP Address | <input type="text" value="192"/> | <input type="text" value="168"/> | <input type="text" value="1"/> | <input type="text" value="1"/> |
| Subnet Mask | <input type="text" value="255"/> | <input type="text" value="255"/> | <input type="text" value="255"/> | <input type="text" value="0"/> |
| Gateway | <input type="text" value="0"/> | <input type="text" value="0"/> | <input type="text" value="0"/> | <input type="text" value="0"/> |
| Local DNS | <input type="text" value="0"/> | <input type="text" value="0"/> | <input type="text" value="0"/> | <input type="text" value="0"/> |

Local IP Address: IP address of the router

Subnet Mask: the subnet mask of the router

Gateway: set internal gateway of the router. If default, internal gateway is the address of the router

Local DNS: DNS server is auto assigned by network operator server. Users enable to use their own DNS server or other stable DNS servers, if not, keep it default

Network Address Server Settings (DHCP)

These settings for the router's Dynamic Host Configuration Protocol (DHCP) server functionality configuration. The Router can serve as a network DHCP server. DHCP server automatically assigns an IP address for each computer in the network. If they choose to enable the router's DHCP server option, users can set all the computers on the LAN to automatically obtain an IP address and DNS, and make sure no other DHCP server in the network.

| | |
|----------------------|---|
| DHCP Type | <input type="text" value="DHCP Server"/> |
| DHCP Server | <input checked="" type="radio"/> Enable <input type="radio"/> Disable |
| Start IP Address | 192.168.1. <input type="text" value="100"/> |
| Maximum DHCP Users | <input type="text" value="50"/> |
| Client Lease Time | <input type="text" value="1440"/> minutes |
| Static DNS 1 | <input type="text" value="0"/> . <input type="text" value="0"/> . <input type="text" value="0"/> . <input type="text" value="0"/> |
| Static DNS 2 | <input type="text" value="0"/> . <input type="text" value="0"/> . <input type="text" value="0"/> . <input type="text" value="0"/> |
| Static DNS 3 | <input type="text" value="0"/> . <input type="text" value="0"/> . <input type="text" value="0"/> . <input type="text" value="0"/> |
| WINS | <input type="text" value="0"/> . <input type="text" value="0"/> . <input type="text" value="0"/> . <input type="text" value="0"/> |
| Use DNSMasq for DHCP | <input checked="" type="checkbox"/> |
| Use DNSMasq for DNS | <input checked="" type="checkbox"/> |
| DHCP-Authoritative | <input checked="" type="checkbox"/> |

DHCP Type: DHCP Server and DHCP Forwarder

Enter DHCP Server if set DHCP Type to DHCP Forwarder as blow:

| | |
|-------------|---|
| DHCP Type | <input type="text" value="DHCP Forwarder"/> |
| DHCP Server | <input type="text" value="0"/> . <input type="text" value="0"/> . <input type="text" value="0"/> . <input type="text" value="0"/> |

DHCP Server: keep the default Enable to enable the router's DHCP server option. If users have already have a DHCP server on their network or users do not want a DHCP server, then select Disable

Start IP Address: enter a numerical value for the DHCP server to start with when issuing IP addresses. Do not start with 192.168.1.1 (the router's own IP address).

Maximum DHCP Users: enter the maximum number of PCs that users want the DHCP server to assign IP addresses to. The absolute maximum is 253 if 192.168.1.2 is users' starting IP address.

Client Lease Time: the Client Lease Time is the amount of time a network user will be allowed connection to the router with their current dynamic IP address. Enter the amount of time, in minutes, that the user will be "leased" this dynamic IP address.

Static DNS (1-3): the Domain Name System (DNS) is how the Internet translates domain or website names into Internet addresses or URLs. Users' ISP will provide them with at least one DNS Server IP address. If users wish to utilize another, enter that IP address in one of these fields. Users can enter up to three DNS Server IP addresses here. The router will utilize them for quicker access to functioning DNS servers.

WINS: the Windows Internet Naming Service (WINS) manages each PC's interaction with the Internet. If users use a WINS server, enter that server's IP address here. Otherwise, leave it blank.

DNSMasq: users' domain name in the field of local search, increase the expansion of the host option, to adopt DNSMasq can assign IP addresses and DNS for the subnet, if select DNSMasq, dhcpd service is used for the subnet IP address and DNS.

Time Settings

Select time zone of your location. To use local time, leave the checkmark in the box next to Use local time.

NTP Client Enable Disable

Time Zone

Summer Time (DST)

Server IP/Name

NTP Client: Get the system time from NTP server

Time Zone: Time zone options

Summer Time (DST): set it depends on users' location

Server IP/Name: IP address of NTP server, up to 32 characters. If blank, the system will find a server by default

Adjust Time

Time : :

To adjust time by the system and refresh to get the time of the web, user can set to modify the time of the system. They can change to adjust time by manual to achieve adjust time by the system if the system fails to get NTP server

3.3.1.2 Dynamic DNS

If user's network has a permanently assigned IP address, users can register a domain name and have that name linked with their IP address by public Domain Name Servers (DNS). However, if their Internet account uses a dynamically assigned IP address, users will not know in advance what their IP address will be, and the address can change frequently. In this case, users can use a commercial dynamic DNS service, which allows them to register their domain to their IP address, and will forward traffic directed at their domain to their frequently-changing IP address.

DDNS Service: Four-Faith router currently support DynDNS, freedns, Zoneedit, NO-IP, 3322, easyDNS, TZO, DynSIP and Custom based on the user.

DDNS Service

User Name

Password Unmask

Host Name

Type ▾

Wildcard

Do not use external ip check Yes No

User Name: users register in DDNS server, up to 64 characteristic

Password: password for the user name that users register in DDNS server, up to 32 characteristic

Host Name: users register in DDNS server, no limited for input characteristic for now

Type: depends on the server

Wildcard: support wildcard or not, the default is OFF. ON means *.host.3322.org is equal to host.3322.org

Do not use external ip check: enable or disable the function of 'do not use external ip check'

Force Update Interval (Default: 10 Days, Range: 1 - 60)

Force Update Interval: unit is day, try forcing the update dynamic DNS to the server by setted days

Status

```

DDNS Status
Fri Nov 25 13:58:32 2011: INADYN: Started 'INADYN Advanced version 1.96-ADV' - dynamic DNS updater.
Fri Nov 25 13:58:32 2011: INADYN: IP read from cache file is '192.168.8.222'. No update required.
Fri Nov 25 13:58:32 2011: I:INADYN: IP address for alias 'testsixin.3322.org' needs update to '192.168.8.38'
Fri Nov 25 13:58:33 2011: I:INADYN: Alias 'testsixin.3322.org' to IP '192.168.8.38' updated successfully.
    
```

DDNS Status shows connection log information

3.3.1.3 Clone MAC Address

Some ISP need the users to register their MAC address. The users can clone the router MAC address to their MAC address registered in ISP if they do not want to re-register their MAC address

Enable Disable

Clone LAN MAC

Clone WAN MAC

[Get Current PC MAC Address](#)

Clone Wireless MAC

Clone MAC address can clone three parts: Clone LAN MAC, Clone WAN MAC, Clone Wireless MAC.

Noted that one MAC address is 48 characteristic, can not be set to the multicast address, the first byte must be even. And MAC address value of network bridge br0 is determined by the smaller value of wireless MAC address and LAN port MAC address.

3.3.1.4 Advanced Router

Operating Mode: Gateway and Router

Operating Mode

Operating Mode

If the router is hosting users' Internet connection, select Gateway mode. If another router exists on their network, select Router mode.

Dynamic Routing

Dynamic Routing

Interface

Dynamic Routing enables the router to automatically adjust to physical changes in the network's layout and exchange routing tables with other routers. The router determines the network packets' route based on the fewest number of hops between the source and destination.

To enable the Dynamic Routing feature for the WAN side, select WAN. To enable this feature for the LAN and wireless side, select LAN&WLAN. To enable the feature for both the WAN and LAN, select Both. To disable the Dynamic Routing feature for all data transmissions, keep the default setting, Disable.

Note: Dynamic Routing is not available in Gateway mode

Static Routing

Static Routing

Select set number:

Route Name:

Metric:

Destination LAN NET: ...

Subnet Mask: ...

Gateway: ...

Interface:

Select set number: 1-50

Route Name: defined routing name by users, up to 25 characters

Metric: 0-9999

Destination LAN NET: the Destination IP Address is the address of the network or host to which users want to assign a static route

Subnet Mask: the Subnet Mask determines which portion of an IP address is the network portion, and which portion is the host portion

Gateway: IP address of the gateway device that allows for contact between the router and the network or host.

Interface: indicate users whether the Destination IP Address is on the LAN & WLAN (internal wired and wireless networks), the WAN (Internet), or Loopback (a dummy network in which one PC acts like a network, necessary for certain software programs)

Show Routing Table

| Routing Table Entry List | | | |
|--------------------------|-----------------|-------------|------------|
| Destination LAN NET | Subnet Mask | Gateway | Interface |
| 192.168.1.1 | 255.255.255.255 | 0.0.0.0 | WAN |
| 192.168.1.0 | 255.255.255.0 | 0.0.0.0 | LAN & WLAN |
| 192.168.1.0 | 255.255.255.0 | 0.0.0.0 | WAN |
| 169.254.0.0 | 255.255.0.0 | 0.0.0.0 | WAN |
| 0.0.0.0 | 0.0.0.0 | 192.168.1.1 | LAN & WLAN |

3.3.1.5 VLANs

VLAN

| VLAN | Port | | | | | Assigned To Bridge |
|------|-------------------------------------|-------------------------------------|-------------------------------------|-------------------------------------|-------------------------------------|---------------------------------------|
| | W | 1 | 2 | 3 | 4 | |
| 0 | <input type="checkbox"/> | <input checked="" type="checkbox"/> | <input checked="" type="checkbox"/> | <input checked="" type="checkbox"/> | <input checked="" type="checkbox"/> | LAN <input type="button" value="v"/> |
| 1 | <input checked="" type="checkbox"/> | <input type="checkbox"/> | <input type="checkbox"/> | <input type="checkbox"/> | <input type="checkbox"/> | None <input type="button" value="v"/> |
| 2 | <input type="checkbox"/> | <input type="checkbox"/> | <input type="checkbox"/> | <input type="checkbox"/> | <input type="checkbox"/> | None <input type="button" value="v"/> |
| 3 | <input type="checkbox"/> | <input type="checkbox"/> | <input type="checkbox"/> | <input type="checkbox"/> | <input type="checkbox"/> | None <input type="button" value="v"/> |
| 4 | <input type="checkbox"/> | <input type="checkbox"/> | <input type="checkbox"/> | <input type="checkbox"/> | <input type="checkbox"/> | None <input type="button" value="v"/> |
| 5 | <input type="checkbox"/> | <input type="checkbox"/> | <input type="checkbox"/> | <input type="checkbox"/> | <input type="checkbox"/> | None <input type="button" value="v"/> |
| 6 | <input type="checkbox"/> | <input type="checkbox"/> | <input type="checkbox"/> | <input type="checkbox"/> | <input type="checkbox"/> | None <input type="button" value="v"/> |
| 7 | <input type="checkbox"/> | <input type="checkbox"/> | <input type="checkbox"/> | <input type="checkbox"/> | <input type="checkbox"/> | None <input type="button" value="v"/> |
| 8 | <input type="checkbox"/> | <input type="checkbox"/> | <input type="checkbox"/> | <input type="checkbox"/> | <input type="checkbox"/> | None <input type="button" value="v"/> |
| 9 | <input type="checkbox"/> | <input type="checkbox"/> | <input type="checkbox"/> | <input type="checkbox"/> | <input type="checkbox"/> | None <input type="button" value="v"/> |
| 10 | <input type="checkbox"/> | <input type="checkbox"/> | <input type="checkbox"/> | <input type="checkbox"/> | <input type="checkbox"/> | None <input type="button" value="v"/> |
| 11 | <input type="checkbox"/> | <input type="checkbox"/> | <input type="checkbox"/> | <input type="checkbox"/> | <input type="checkbox"/> | None <input type="button" value="v"/> |
| 12 | <input type="checkbox"/> | <input type="checkbox"/> | <input type="checkbox"/> | <input type="checkbox"/> | <input type="checkbox"/> | None <input type="button" value="v"/> |
| 13 | <input type="checkbox"/> | <input type="checkbox"/> | <input type="checkbox"/> | <input type="checkbox"/> | <input type="checkbox"/> | None <input type="button" value="v"/> |
| 14 | <input type="checkbox"/> | <input type="checkbox"/> | <input type="checkbox"/> | <input type="checkbox"/> | <input type="checkbox"/> | None <input type="button" value="v"/> |
| 15 | <input type="checkbox"/> | <input type="checkbox"/> | <input type="checkbox"/> | <input type="checkbox"/> | <input type="checkbox"/> | None <input type="button" value="v"/> |

VLANs function is to divide different VLAN ports by users' will. The system supports 16 VLAN port from VLAN0-VLAN15. However there is only 5 time ports (1 WAN port and 4 LAN port) divided by users themselves, and LAN port and WAN port disable to divide into one VLAN port meanwhile.

3.3.1.6 Networking

Bridging

Create Bridge

Bridge 0 STP Prio MTU

Assign to Bridge

Current Bridging Table

| Bridge Name | STP enabled | Interfaces |
|-------------|-------------|------------|
| br0 | no | vlan0 ra0 |

Bridging-Create Bridge: creates a new empty network bridge for later use. STP means Spanning Tree Protocol and with PRIO users are able to set the bridge priority order. The lowest number has the highest priority.

Bridging - Assign to Bridge: allows users to assign any valid interface to a network bridge. Consider setting the Wireless Interface options to Bridged if they want to assign any Wireless Interface here. Any system specific bridge setting can be overridden here in this field.

Current Bridging Table: shows current bridging table

Create steps as below:

Click 'Add' to create a new bridge, configuration is as below:

Create Bridge

| | | | | | |
|------------------------------------|----------------------------------|--|---|---------------------------------------|---------------------------------------|
| Bridge 0 | <input type="text" value="br0"/> | STP <input type="button" value="Off"/> | Prio <input type="text" value="32768"/> | MTU <input type="text" value="1500"/> | |
| Bridge 1 | <input type="text" value="br1"/> | STP <input type="button" value="On"/> | Prio <input type="text" value="32768"/> | MTU <input type="text" value="1500"/> | <input type="button" value="Delete"/> |
| <input type="button" value="Add"/> | | | | | |

Create bridge option: the first br0 means bridge name. STP means to on/off spanning tree protocol. Prio means priority level of STP, the smaller the number, the higher the level. MTU means maximum transfer unit, default is 1500, delete if it is not need. And then click 'Save' or 'Add'. Bride properties is as below:

Create Bridge

| | | | | | |
|------------------------------------|----------------------------------|--|---|---------------------------------------|---------------------------------------|
| Bridge 0 | <input type="text" value="br0"/> | STP <input type="button" value="Off"/> | Prio <input type="text" value="32768"/> | MTU <input type="text" value="1500"/> | <input type="button" value="Delete"/> |
| Bridge 1 | <input type="text" value="br1"/> | STP <input type="button" value="On"/> | Prio <input type="text" value="32768"/> | MTU <input type="text" value="1500"/> | <input type="button" value="Delete"/> |
| IP Address | <input type="text" value="0"/> | <input type="text" value="0"/> | <input type="text" value="0"/> | <input type="text" value="0"/> | |
| Subnet Mask | <input type="text" value="0"/> | <input type="text" value="0"/> | <input type="text" value="0"/> | <input type="text" value="0"/> | |
| <input type="button" value="Add"/> | | | | | |

Enter relewant bridge IP address and subnet mask, click 'Add' to create a bridge.

Note: Only create a bride can apply it.

Assign to Bridge

| | | | | |
|------------------------------------|-------------------------------------|--|--------------------------------------|---------------------------------------|
| Assignment 0 | <input type="button" value="none"/> | Interface <input type="text" value="ra0"/> | Prio <input type="text" value="63"/> | <input type="button" value="Delete"/> |
| <input type="button" value="Add"/> | | | | |

Assign to Bridge option: to assign different ports to created bridge. For example: assign port (wireless port) is ra0 in br1 bridge as below:

Prio means priority level: work if multiple ports are within the same bridge. The smaller the number, the higher the level. Click 'Add' to take it effect.

Note: corresponding interface of WAN ports interface should not be binding, this bridge function is basically used for LAN port, and should not be binding with WAN port

If bind success, bridge binding list in the list of current bridging table is as below:

Current Bridging Table

| Bridge Name | STP enabled | Interfaces |
|-------------|-------------|------------|
| br0 | no | vlan0 |
| br1 | yes | ra0 |

Auto-Refresh is On

To make br1 bridge has the same function with DHCP assigned address, users need to set multiple DHCP function, see the introduction of multi-channel DHCPD:

Port Setup

| | | |
|------------------------------|---------------------------------|--|
| Network Configuration eth2 | <input type="radio"/> Unbridged | <input checked="" type="radio"/> Default |
| Network Configuration vlan0 | <input type="radio"/> Unbridged | <input checked="" type="radio"/> Default |
| Network Configuration ra0 | <input type="radio"/> Unbridged | <input checked="" type="radio"/> Default |
| Network Configuration apcli0 | <input type="radio"/> Unbridged | <input checked="" type="radio"/> Default |
| Network Configuration wds0 | <input type="radio"/> Unbridged | <input checked="" type="radio"/> Default |
| Network Configuration wds1 | <input type="radio"/> Unbridged | <input checked="" type="radio"/> Default |
| Network Configuration wds2 | <input type="radio"/> Unbridged | <input checked="" type="radio"/> Default |
| Network Configuration wds3 | <input type="radio"/> Unbridged | <input checked="" type="radio"/> Default |
| Network Configuration br0 | <input type="radio"/> Unbridged | <input checked="" type="radio"/> Default |

Port Setup: Set the port property, the default is not set

| | | |
|---------------------------|---|--|
| Network Configuration ra0 | <input checked="" type="radio"/> Unbridged | <input type="radio"/> Default |
| MTU | <input type="text" value="1500"/> | |
| Multicast forwarding | <input type="radio"/> Enable | <input checked="" type="radio"/> Disable |
| Masquerade / NAT | <input checked="" type="radio"/> Enable | <input type="radio"/> Disable |
| IP Address | <input type="text" value="0"/> . <input type="text" value="0"/> . <input type="text" value="0"/> . <input type="text" value="0"/> | |
| Subnet Mask | <input type="text" value="0"/> . <input type="text" value="0"/> . <input type="text" value="0"/> . <input type="text" value="0"/> | |

Choose not bridge to set the port's own properties, detailed properties are as below:

MTU: maximum transfer unit

Multicast forwarding: enable or disable multicast forwarding

Masquerade/NAT: enable or disable Masquerade/NAT

IP Address: set ra0's IP address, and do not conflict with other ports or bridge

Subnet Mask: set the port's subnet mask

Multiple DHCP Server

DHCP 0 ra0 On Start Max Leasetime

Multiple DHCPD: using multiple DHCP service. Click 'Add' in multiple DHCP server to appear relevant configuration. The first means the name of port or bridge (do not be configured as eth0), the second means whether to on DHCP. Start means start address, Max means maximum assigned DHCP clients, Leasetime means the client lease time, the unit is second, click 'Save' or 'Apply' to put it into effect after setting.

Note: Only configure and click 'Save' can configure the next, can not configure multiple DHCP at the same time.

3.3.2 Wireless

3.3.2.1 Basic Settings

Wireless Physical Interface w10 [2.4 GHz]

Wireless Network Enable Disable

Physical Interface ra0 - SSID [dd-junjinlee] HWAddr [00:AA:BB:CC:DD:15]

Wireless Mode

Wireless Network Mode

802.11n Transmission Mode

Wireless Network Name (SSID)

Wireless Channel

Channel Width

Extension Channel

Wireless SSID Broadcast Enable Disable

Network Configuration Unbridged Bridged

Virtual Interfaces

Wireless Network: “Eanble”, radio on.
 “Disable”, radio off.

Wireless Mode: AP, Client, Adhoc, Repeater, Repeater Bridge four options.

Wireless Network Mode:

Mixed: Support 802.11b, 802.11g, 802.11n wireless devices.

BG-Mixed: Support 802.11b, 802.11g wireless devices.

B-only: Only supports the 802.11b standard wireless devices.

B-only: Only supports the 802.11b standard wireless devices.

G-only: Only supports the 802.11g standard wireless devices.

NG-Mixed: Support 802.11g, 802.11n wireless devices.

N-only: Only supports the 802.11g standard wireless devices.

802.11n Transmission Mode: In the wireless network mode to "N-only" choose to transfer its transmission mode.

Greenfield: When you determine the surrounding environment, there is no other 802.11a/b/g devices use the same channel, use this mode to increase throughput. Other 802.11a/b/g devices use the same channel in the environment, the information you send may generate an error, re-issued.

Mixed: This mode is contrary to the green mode, but will reduce the throughput.

Wireless Network Name(SSID): The SSID is the network name shared among all devices in a wireless network. The SSID must be identical for all devices in the wireless network. It is case-sensitive and must not exceed 32 alphanumeric characters, which may be any keyboard character. Make sure this setting is the same for all devices in your wireless network.。

Wireless Channel: A total of 1-13 channels to choose more than one wireless device environment, please try to avoid using the same channel with other devices.。

Channel Width: 20MHZ and 40MHZ.。

Extension Channel: Channel for 40MHZ, you can choose upper or lower.

Wireless SSID Broadcast:

Enable: SSID broadcasting.

Disable: Hidden SSID.

Network Configuration:

Bridged: Bridge to the router, under normal circumstances, please select the bridge.

Unbridged: There is no bridge to the router, IP addresses need to manually configure.

| | |
|-----------------------|---|
| Network Configuration | <input checked="" type="radio"/> Unbridged <input type="radio"/> Bridged |
| Multicast forwarding | <input type="radio"/> Enable <input checked="" type="radio"/> Disable |
| Masquerade / NAT | <input checked="" type="radio"/> Enable <input type="radio"/> Disable |
| IP Address | <input type="text" value="192"/> . <input type="text" value="168"/> . <input type="text" value="1"/> . <input type="text" value="1"/> |
| Subnet Mask | <input type="text" value="255"/> . <input type="text" value="255"/> . <input type="text" value="0"/> . <input type="text" value="0"/> |

Virtual Interfaces: Click Add to add a virtual interface. Add successfully, click on the remove, you can remove the virtual interface.。

Virtual Interfaces

Virtual Interfaces ra1 SSID [dd-wrt_vap] HWAddr [00:AA:BB:CC:DD:16]

| | |
|------------------------------|--|
| Wireless Network Name (SSID) | <input type="text" value="dd-wrt_vap"/> |
| Wireless SSID Broadcast | <input checked="" type="radio"/> Enable <input type="radio"/> Disable |
| AP Isolation | <input type="radio"/> Enable <input checked="" type="radio"/> Disable |
| Network Configuration | <input type="radio"/> Unbridged <input checked="" type="radio"/> Bridged |

AP Isolation: This setting isolates wireless clients so access to and from other wireless clients are stopped.

Note : Save your changes, after changing the "Wireless Mode", "Wireless Network Mode", "wireless width", "broadband" option, please click on this button, and then configure the other options.

3.3.2.2 Wireless Security

Wireless security options used to configure the security of your wireless network. This route is a total of seven kinds of wireless security mode. Disabled by default, not safe mode is enabled. Such as changes in Safe Mode, click Apply to take effect immediately.

Wireless Security w10

Physical Interface ra0 SSID [dd-junjinlee] HWAddr [00:AA:BB:CC:DD:15]

| | |
|---------------|---|
| Security Mode | <input type="text" value="Disabled"/> ▼ |
|---------------|---|

Wireless Security w10

Physical Interface ra0 SSID [four-faith] HWAddr [00:0C:43:30:52:79]

Security Mode: WEP

Authentication Type: Open Shared Key

Default Transmit Key: 1 2 3 4

Encryption: 64 bits 10 hex digits/5 ASCII

ASCII/HEX: ASCII HEX

Passphrase: 1111111111111111

Key 1: 2627F68597

Key 2: 15AD1DD294

Key 3: DDC4761939

Key 4: 31F1ADB558

WEP: Is a basic encryption algorithm is less secure than WPA. Use of WEP is discouraged due to security weaknesses, and one of the WPA modes should be used whenever possible. Only use WEP if you have clients that can only support WEP (usually older, 802.11b-only clients).

Authentication Type: Open or shared key.

Default Transmit Key: Select the key form Key 1 - Key 4 key.

Encryption: There are two levels of WEP encryption, 64-bit (40-bit) and 128-bit. To utilize WEP, select the desired encryption bit, and enter a passphrase or up to four WEP key in hexadecimal format. If you are using 64-bit (40-bit), then each key must consist of exactly 10 hexadecimal characters or 5 ASCII characters. For 128-bit, each key must consist of exactly 26 hexadecimal characters. Valid hexadecimal characters are "0"- "9" and "A"- "F".

ASCII/HEX: ASCII, the keys is 5 bit ASCII characters/13bit ASCII characters.

HEX, the keys is 10bit/26 bit hex digits.

Passphrase: The letters and numbers used to generate a key.

Key1-Key4: Manually fill out or generated according to input the pass phrase.

Wireless Security w10

Physical Interface ra0 SSID [dd-junjinlee] HWAddr [00:AA:BB:CC:DD:15]

Security Mode: WPA Personal

WPA Algorithms: AES

WPA Shared Key: Unmask

Key Renewal Interval (in seconds): 3600 (Default: 3600, Range: 1 - 99999)

WPA Personal/WPA2 Personal/WPA2 Person Mixed: , TKIP/AES/TKIP+AES , dynamic

encryption keys. TKIP + AES, self-applicable TKIP or AES. WPA Person Mixed, allow WPA Personal and WPA2 Personal client mix.

WPA Shared Key: Between 8 and 63 ASCII character or hexadecimal digits.。

Key Renewal Interval (in seconds): 1-99999.。

Wireless Security w10

Physical Interface ra0 SSID [dd-junjinlee] HWAddr [00:AA:BB:CC:DD:15]

Security Mode: WPA Enterprise

WPA Algorithms: AES

Radius Auth Server Address: 192.168.1.110

Radius Auth Server Port: 1812 (Default: 1812)

Radius Auth Shared Secret: [masked] Unmask

Key Renewal Interval (in seconds): 3600

WPA Enterprise/WPA2 Enterprise/WPA2 Enterprise Mixed: WPA Enterprise uses an external RADIUS server to perform user authentication.

WPA Algorithms: AES/TKIP/TPIP+AES.

Radius Auth Sever Address: The IP address of the RADIUS server.

Radius Auth Server Port: The RADIUS Port (default is 1812)。

Radius Auth Shared Secret: The shared secret from the RADIUS server.。

Key Renewal Interva(in seconds): 1-99999.。

Wireless Security w10

Physical Interface ra0 SSID [dd-junjinlee] HWAddr [00:AA:BB:CC:DD:15]

Security Mode: 802.1x

XSupplicant Type: Peap TTLS

User: [text box]

Anonymous Identity: [text box]

Password: [text box]

Phase2: [text box]

Public Server Certificate: [list box]

Additional Network Options: [list box]

802.1x: 802.1x for user to connect to a wireless access point and cable converter to provide the certification. It will limit without obtaining the user credentials to connect to the Internet,

credentials - for example, a separate server authentication user name and password.

Peap: PEAP (Protected Extensible Authentication Protocol) is a version of EAP, the authentication protocol used in wireless networks and Point-to-Point connections. PEAP is designed to provide more secure authentication for 802.11 WLANs (wireless local area networks) that support 802.1X port access control. Here is PEAP-EAP-MS-CHAPv2.

1. Enter the User.
2. Enter the Password.

TTLS: TTLS uses the TLS channel to exchange "attribute-value pairs" (AVPs), much like RADIUS. (In fact, the AVP encoding format is very similar to RADIUS.) The general encoding of information allows a TTLS server to validate AVPs against any type of authentication mechanism. TTLS implementations today support all methods defined by EAP, as well as several older methods (CHAP, PAP, MS-CHAP and MS-CHAPv2). TTLS can easily be extended to work with new protocols by defining new attributes to support new protocols.

1. Enter the User.
2. Enter the Password.
3. Enter the Public Server Certificate.

3.3.2.3 Wireless MAC Filter

The Wireless MAC Filter allows you to control which wireless-equipped PCs may or may not communicate with the router depending on their MAC addresses. For information how to get MAC addresses from Windows-PCs, see MAC Address Cloning for detailed instructions.

Wireless MAC Filter

ra0 - MAC Filter

Use Filter Enable Disable

Filter Mode Prevent clients listed from accessing the wireless network
 Permit only clients listed to access the wireless network

[Edit MAC Filter List](#)

[Save](#)
[Apply Settings](#)
[Cancel Changes](#)

Use Filter: Disabled by default. Select Enable to open the Wireless MAC Filter.

Filter Mode:

Prevent client listed from accessing the wireless network: If you want to block specific wireless-equipped PCs from communicating with the router, then keep the default setting, Prevent PCs listed from accessing the wireless network.

Permit only client listed to accessing the wireless network: If you want to allow specific wireless-equipped PCs to communicate with the router, then click the radio button next to Permit only PCs listed to access the wireless network.

Click the Edit MAC Filter List button. Enter the appropriate MAC addresses into the MAC fields

3.3.2.4 Advance Settings

The Wireless Advanced Settings screen allows you to customize data transmission settings. In most cases, the advanced settings on this screen should remain at their default values.

| Advanced Wireless Settings | | |
|--------------------------------|---|-------------------------------------|
| Advanced Settings | | |
| Basic Rate | Default <input type="button" value="v"/> | (Default: Default) |
| MIMO - Transmission Fixed Rate | Auto <input type="button" value="v"/> | (Default: Auto) |
| Transmission Fixed Rate | Auto <input type="button" value="v"/> | (Default: Auto) |
| CTS Protection Mode | <input checked="" type="radio"/> Auto <input type="radio"/> Disable | (Default: Auto) |
| Frame Burst | <input checked="" type="radio"/> Enable <input type="radio"/> Disable | |
| Beacon Interval | <input type="text" value="100"/> | (Default: 100ms, Range: 10 - 65535) |
| DTIM Interval | <input type="text" value="1"/> | (Default: 1, Range: 1 - 255) |
| Fragmentation Threshold | <input type="text" value="2346"/> | (Default: 2346, Range: 256 - 2346) |
| RTS Threshold | <input type="text" value="2347"/> | (Default: 2347, Range: 0 - 2347) |
| Max Associated Clients | <input type="text" value="128"/> | (Default: 128, Range: 1 - 256) |
| AP Isolation | <input type="radio"/> Enable <input checked="" type="radio"/> Disable | (Default: Disable) |
| TX Antenna | Auto <input type="button" value="v"/> | (Default: Auto) |
| RX Antenna | Auto <input type="button" value="v"/> | (Default: Auto) |
| Preamble | Long <input type="button" value="v"/> | (Default: Long) |
| Shortslot Override | Auto <input type="button" value="v"/> | (Default: Auto) |
| TX Power | <input type="text" value="71"/> | (Default: 71, Range: 1 - 251mW) |
| Wireless GUI Access | <input checked="" type="radio"/> Enable <input type="radio"/> Disable | (Default: Enable) |

Basic Rate: The default value is set to Default. Depending on the wireless mode you have selected, a default set of supported data rates will be selected. The default setting will ensure maximum compatibility with all devices. You may also choose to enable all data rates by selecting ALL. For compatibility with older Wireless-B devices, select 1-2Mbps.

MIMO-Transmission Fixed Rate : The default setting is Auto. The range is from 13.5 to 270Mbps. The rate of data transmission should be set depending on the speed of your wireless network. You can select from a range of transmission speeds, or keep the default setting, Auto, to have the router automatically use the fastest possible data rate and enable the Auto-Fallback feature. Auto-Fallback will negotiate the best possible connection speed between the router and a

wireless client.

Transmission Fixed Rate: The default setting is Auto. The range is from 1 to 54Mbps. The rate of data transmission should be set depending on the speed of your wireless network. You can select from a range of transmission speeds, or keep the default setting, Auto, to have the router automatically use the fastest possible data rate and enable the Auto-Fallback feature. Auto-Fallback will negotiate the best possible connection speed between the router and a wireless client.

CTS Protection Mode: The default value is disabled. When set to Auto, a protection mechanism will ensure that your Wireless-B devices will connect to the Wireless-G router when many Wireless-G devices are present. However, performance of your Wireless-G devices may be decreased.

Frame Burst: The default value is disabled. Frame burst allows packet bursting which will increase overall network speed though this is only recommended for approx 1-3 wireless clients, Any more clients and there can be a negative result and throughput will be affected.

Beacon Interval: The default value is 100. Enter a value between 1 and 65,535 milliseconds. The Beacon Interval value indicates the frequency interval of the beacon. A beacon is a packet broadcast by the router to synchronize the wireless network. 50 is recommended in poor reception.

DTIM Interval: The default value is 1. This value, between 1 and 255, indicates the interval of the Delivery Traffic Indication Message (DTIM). A DTIM field is a countdown field informing clients of the next window for listening to broadcast and multicast messages. When the router has buffered broadcast or multicast messages for associated clients, it sends the next DTIM with a DTIM Interval value. Its clients hear the beacons and awaken to receive the broadcast and multicast messages.

Fragmentation Threshold: This value should remain at its default setting of 2346. The range is 256-2346 bytes. It specifies the maximum size for a packet before data is fragmented into multiple packets. If you experience a high packet error rate, you may slightly increase the Fragmentation Threshold. Setting the Fragmentation Threshold too low may result in poor network performance. Only minor modifications of this value are recommended.

RTS Threshold: This value should remain at its default setting of 2347. The range is 0-2347 bytes. Should you encounter inconsistent data flow, only minor modifications are recommended. If a network packet is smaller than the preset RTS threshold size, the RTS/CTS mechanism will not be enabled. The router sends Request to Send (RTS) frames to a particular receiving station and negotiates the sending of a data frame. After receiving an RTS, the wireless station responds with a Clear to Send (CTS) frame to acknowledge the right to begin transmission.

Max Associated Clients: 1-128.

AP Isolation: The default value is Off. This setting isolates wireless clients so access to and from other wireless clients are stopped.

TX Antenna/ RX Antenna: Values are Auto, Left, Right, default value is Auto. This is used in conjunction with external antennas to give them optimum performance. On some router models left and right antennas may be reversed depending on you point of view.

Xiamen Four-Faith Communication Technology Co.,Ltd.

Page 40 of 90

Add: J1-J3,3rdFloor,No.44,GuanRiRoad,SoftWare Park,XiaMen .361008.China

http: //www.fourfaith.com Tel: +86 592-6300326 6300325 6300324 Fax: +86 592-5912735

Preamble: Values are Long and Short, default value is Long. If your wireless device supports the short preamble and you are having trouble getting it to communicate with other 802.11b devices, make sure that it is set to use the long preamble.

Wireless GUI Access: The default value is Enabled. The setting allows access to the routers setup (GUI) from wireless clients. Disable this if you wish to block all wireless clients from accessing the setup pages.

Radio Time Restrictions

Radio Scheduling Enable Disable (Default: Disable)

0 1 2 3 4 5 6 7 8 9 10 11 12 13 14 15 16 17 18 19 20 21 22 23

Always On Always Off

Radio Time Restrictions: The *Radio Times Restriction* facility constitutes a time switch for the radio. By default, the time switch is not active and the WLAN is permanently on. Enable the time switch, if you want to turn off the WLAN during some hours of the day. Hours during which the WLAN is on are marked in green, while red indicates that the radio is off. Clicking on the respective hour toggles between on and off.

Wireless Multimedia Support Settings

WMM Support Enable Disable (Default: Enable)

No-Acknowledgement Enable Disable (Default: Disable)

EDCA AP Parameters (AP to Client)

| | CWmin | CWmax | AIFSN | TXOP(b) | TXOP(a/g) | Admin Forced |
|-------------|-------|-------|-------|---------|-----------|--------------------------|
| Background | 15 | 1023 | 7 | 0 | 0 | <input type="checkbox"/> |
| Best Effort | 15 | 63 | 3 | 0 | 0 | <input type="checkbox"/> |
| Video | 7 | 15 | 1 | 6016 | 3008 | <input type="checkbox"/> |
| Voice | 3 | 7 | 1 | 3264 | 1504 | <input type="checkbox"/> |

EDCA STA Parameters (Client to AP)

| | CWmin | CWmax | AIFSN | TXOP(b) | TXOP(a/g) | Admin Forced |
|-------------|-------|-------|-------|---------|-----------|--------------------------|
| Background | 15 | 1023 | 7 | 0 | 0 | <input type="checkbox"/> |
| Best Effort | 15 | 1023 | 3 | 0 | 0 | <input type="checkbox"/> |
| Video | 7 | 15 | 2 | 6016 | 3008 | <input type="checkbox"/> |
| Voice | 3 | 7 | 2 | 3264 | 1504 | <input type="checkbox"/> |

WMM Tx retry limits, fallback limits and max rate parameters.

| | S. Retry | S. Fallbk | L. Retry | L. Fallbk | Max Rate |
|-------------|----------|-----------|----------|-----------|----------|
| Background | 7 | 3 | 4 | 2 | 0 |
| Best Effort | 7 | 3 | 4 | 2 | 0 |
| Video | 7 | 3 | 4 | 2 | 0 |
| Voice | 7 | 3 | 4 | 2 | 0 |

Wireless Multimedia Support Settings: Enable support of Wi-Fi Multimedia feature.

Configuring QoS options consists of setting parameters on existing queues for different types of wireless traffic. You can configure different minimum and maximum wait times for the

Xiamen Four-Faith Communication Technology Co.,Ltd.

transmission of packets in each queue based on the requirements of the media being sent. Queues automatically provide minimum transmission delay for Voice, Video, multimedia, and mission critical applications, and rely on best-effort parameters for traditional IP data

No-Acknowledgement: This refers to the acknowledge policy used at the MAC level. Enabling no-acknowledgement can result in more efficient throughput but higher error rates in a noisy Radio Frequency (RF) environment

EDCA AP Parameters (AP to Client): This affects traffic flowing from the access point to the client station.

EDCA STA Parameters (Client to AP): This affects traffic flowing from the client station to the access point.

Background: Priority is low.

High throughput. Bulk data that requires maximum throughput and is not time-sensitive is sent to this queue (FTP data, for example).

Best Effort: Priority is Medium.

Medium throughput and delay. Most traditional IP data is sent to this queue.

Video: Priority is High.

Minimum delay. Time-sensitive video data is automatically sent to this queue.

voice: Priority is High.

Time-sensitive data like VoIP and streaming media are automatically sent to this queue.

CWmin: Minimum Contention Window. This parameter is input to the algorithm that determines the initial random backoff wait time ("window") for retry of a transmission. The value specified here in the Minimum Contention Window is the upper limit (in milliseconds) of a range from which the initial random backoff wait time is determined.

The first random number generated will be a number between 0 and the number specified here. If the first random backoff wait time expires before the data frame is sent, a retry counter is incremented and the random backoff value (window) is doubled. Doubling will continue until the size of the random backoff value reaches the number defined in the Maximum Contention Window. Valid values for the "cwmin" are 1, 3, 7, 15, 31, 63, 127, 255, 511, or 1024. The value for "cwmin" must be lower than the value for "CWmax".

Cmax: Maximum Contention Window. The value specified here in the Maximum Contention Window is the upper limit (in milliseconds) for the doubling of the random backoff value. This doubling continues until either the data frame is sent or the Maximum Contention Window size is reached. Once the Maximum Contention Window size is reached, retries will continue until a maximum number of retries allowed is reached. Valid values for the "cwmax" are 1, 3, 7, 15, 31, 63, 127, 255, 511, or 1024. The value for "cwmax" must be higher than the value for "CWmin".

AIFSN: The Arbitration Inter-Frame Spacing Number specifies a wait time (in milliseconds) for data frames.

TXOP(b)/ TXOP(a/g): Transmission Opportunity for "a" "b" and "g" modes is an interval of time when a WME AP has the right to initiate transmissions onto the wireless medium (WM). This

Xiamen Four-Faith Communication Technology Co.,Ltd.

Page 42 of 90

Add: J1-J3,3rdFloor,No.44,GuanRiRoad,SoftWare Park,XiaMen .361008.China

http: //www.fourfaith.com Tel: +86 592-6300326 6300325 6300324 Fax: +86 592-5912735

value specifies (in milliseconds) the Transmission Opportunity (TXOP) for AP; that is, the interval of time when the WMM AP has the right to initiate transmissions on the wireless network.

3.3.2.5 WDS

WDS (Wireless Distribution System) is a Wireless Access Point mode that enables wireless bridging in which WDS APs communicate only with each other only (without allowing for wireless clients or stations to access them), and/or wireless repeating in which APs communicate both with each other and with wireless stations (at the expense of half the throughput). This firmware currently supports one types of WDS, LAN.

Wireless Distribution System

WDS Settings

Wireless MAC 00:AA:BB:CC:DD:15

| | | | | | | | |
|---------|----|----|----|----|----|----|--|
| LAN | 00 | 00 | 00 | 00 | 00 | 00 | |
| Disable | 00 | 00 | 00 | 00 | 00 | 00 | |
| Disable | 00 | 00 | 00 | 00 | 00 | 00 | |
| Disable | 00 | 00 | 00 | 00 | 00 | 00 | |
| Disable | 00 | 00 | 00 | 00 | 00 | 00 | |
| Disable | 00 | 00 | 00 | 00 | 00 | 00 | |
| Disable | 00 | 00 | 00 | 00 | 00 | 00 | |
| Disable | 00 | 00 | 00 | 00 | 00 | 00 | |
| Disable | 00 | 00 | 00 | 00 | 00 | 00 | |
| Disable | 00 | 00 | 00 | 00 | 00 | 00 | |

Extra Options

Lazy WDS Enable Disable (Default: Disable)

Save
Apply Settings
Cancel Changes

LAN-type WDS

This is the easiest, and currently most common, type of WDS used for linking LANs. It is very simple to setup and requires no extra routing protocols or knowledge of networking. Simply put, it is pure bridging. A simple example would be extending the range of an existing AP by setting up a 2nd AP and connecting it to the first using LAN-type WDS.

1. Make sure you are using the same Wireless Settings on both routers and not any type of Wireless Security.
2. Find a drop-down selection that has Disabled displayed. Click this and select LAN, do the same on the other router.

3. On the first router, take the numbers next to Wireless MAC and enter them in to the second router on the same line that you set to "LAN".
4. Take the Wireless MAC from the second router and enter them on the first router.
5. Check for any typing errors and then click Save Settings.
6. Go to the Wireless Status page. You should see WDS Link and the Wireless MAC of the other router listed, with a signal reading. If the signal is "0dBm" then there may be something wrong. Check your antenna connections and configuration settings, and try again.
7. Once you have a good signal (-70dBm to -30dBm, -70dBm being lowest), you can change the Internet Connection Type on the Basic Setup page of the second router to Disabled and set the *Gateway* to the LAN IP Address of the first router. You can now run normal tests to check if you are connected (like ping).

Lzay WDS: Default is disabled.

Note: WDS is only available in AP mode. Also Wireless encryption WPA2 and Wireless network mode B-Only are not supported under WDS.

3.3.3 Services

3.3.3.1 Services

DHCP Client

| DHCP Client | |
|-----------------|----------------------|
| Set Vendorclass | <input type="text"/> |
| Request IP | <input type="text"/> |

Set Vendorclass: the DHCP server can automatically identify the specific identifier of the computer running certain operating systems to send, such as the DHCP server can identify the DHCP client running the operating system is Windows 2000 or Windows 98. Identification identifier DHCP option can be assigned to DHCP clients based on specific operating system.

Request IP: IP address of the request

DHCP Server

DHCPd assigns IP addresses to users local devices. While the main configuration is on the setup page users can program some nifty special functions here.

DHCP Server

Use JFFS2 for client lease DB (Not mounted)

Use NVRAM for client lease DB

Used Domain WAN

LAN Domain

Additional DHCPd Options

| Static Leases | | | |
|---|---|---|---|
| MAC Address | Host Name | IP Address | Client Lease Time |
| <input style="width: 100%;" type="text"/> | <input style="width: 100%;" type="text"/> | <input style="width: 100%;" type="text"/> | <input style="width: 100%;" type="text"/> minutes |
| <input type="button" value="Add"/> | | <input type="button" value="Remove"/> | |

Use NVRAM for client lease DB: users can store data to the system NVRAM area is enabled

Used domain: users can select here which domain the DHCP clients should get as their local domain. This can be the WAN domain set on the Setup screen or the LAN domain which can be set here.

LAN Domain: users can define here their local LAN domain which is used as local domain for DNSmasq and DHCP service if chose above.

Static Leases: if users want to assign certain hosts a specific address then they can define them here. This is also the way to add hosts with a fixed address to the router's local DNS service (DNSmasq).

Additional DHCPd Options: some extra options users can set by entering them

DNSMasq

DNSmasq is a local DNS server. It will resolve all host names known to the router from dhcp (dynamic and static) as well as forwarding and caching DNS entries from remote DNS servers. Local DNS enables DHCP clients on the LAN to resolve static and dynamic DHCP hostnames.

DNSMasq

DNSMasq Enable Disable

Local DNS Enable Disable

No DNS Rebind Enable Disable

Additional DNSMasq Options

Local DNS: enables DHCP clients on the LAN to resolve static and dynamic DHCP hostnames

No DNS Rebind: when enabled, it can prevent an external attacker to access the router's internal

Web interface. It is a security measure

Additional DNSMasq Options: some extra options users can set by entering them in Additional DNS Options.

For example:

static allocation: dhcp-host=AB:CD:EF:11:22:33,192.168.0.10,myhost,myhost.domain,12h

max lease number: dhcp-lease-max=2

DHCP server IP range: dhcp-range=192.168.0.110,192.168.0.111,12h

SNMP

SNMP

Enable Disable

Location:

Contact:

Name:

RO Community:

RW Community:

Location: equipment location

Contact: contact this equipment management

Name: device name

RO Community: SNMP RO community name, the default is public, Only to read.

RW Community: SNMP RW community name, the default is private, Read-write permissions

SSHD

Enabling SSHd allows users to access the Linux OS of their router with an SSH client

Secure Shell

SSHd: Enable Disable

SSH TCP Forwarding: Enable Disable

Password Login: Enable Disable

Port: (Default: 22)

Authorized Keys:

SSH TCP Forwarding: enable or disable to support the TCP forwarding

Password Login: allows login with the router password (username is admin)

Port: port number for SSHd (default is 22)

Authorized Keys: here users paste their public keys to enable key-based login (more secure than a simple password)

System log

Xiamen Four-Faith Communication Technology Co.,Ltd.

Page 46 of 90

Add: J1-J3,3rdFloor,No.44,GuanRiRoad,SoftWare Park,XiaMen .361008.China

http: //www.fourfaith.com Tel: +86 592-6300326 6300325 6300324 Fax: +86 592-5912735

Enable Syslogd to capture system messages. By default they will be collected in the local file /var/log/messages. To send them to another system, enter the IP address of a remote syslog server.

System Log

Syslogd Enable Disable

Syslog Out Mode Net Console

Remote Server

Syslog Out Mode: two log mode

Net: the log information output to a syslog server

Console: the log information output to console port

Remote Server: if choose net mode, users should input a syslog server's IP Address and run a syslog server program on it.

Telnet

Telnet

Telnet Enable Disable

Telnet: enable a telnet server to connect to the router with telnet. The username is admin and the password is the router's password.

Note: If users use the router in an untrusted environment (for example as a public hotspot), it is strongly recommended to use SSHd and deactivate telnet.

WAN Traffic Counter

WAN Traffic Counter

ttraff Daemon Enable Disable

Ttraff Daemon: enable or disable wan traffic counter function

3.3.3.2 PPPoE Server

PPPoE Server

PPPoE Server

RP-PPPoE Server Daemon Enable Disable

RP-PPPoEServer Daemon: enable or disable PPPoE server

RP-PPPoEServer Options

RP-PPPoE Server Options

| | | |
|---------------------------|--|---------------------------|
| RP-PPPoE Server Interface | LAN | |
| Client IP(s) | 192.168.1.10-100 | |
| Deflate Compression | <input type="checkbox"/> | |
| BSD Compression | <input type="checkbox"/> | |
| LZS Stac Compression | <input type="checkbox"/> | |
| MPPC Compression | <input type="checkbox"/> | |
| MPPE PPPoE Encryption | <input type="checkbox"/> | |
| Session Limit per MAC | 10 | (Default: 10) |
| LCP Echo Interval | 5 | (Default: 5) |
| LCP Echo Failure | 12 | (Default: 12) |
| Idle Time | 0 | (Default: 0 = Deactivate) |
| Authentication | <input type="radio"/> Radius <input checked="" type="radio"/> Local User Management (CHAP Secrets) | |

PPPOE Server Interface: PPPoE server interface to the outside, only to support the LAN port

Client IP(s): IP range assigns to the PPPoE client in the format: xxx.xxx.xxx.xxx-xxx

Deflate Compression: enable or disable Deflate Compression

BSD Compression: enable or disable BSD Compression

LZS Stac Compression: enable or disable LZS Stac Compression

MPPC Compression: enable or disable MPPC Compression

MPPE PPPoE Encryption: enable or disable MPPE PPPoE Encryption

Session Limit per MAC: default is 10

LCP Echo Interval: time interval to set the the LCP calibration phase response

LCP Echo Failure: release PPPoE over failure times, the PPPoE client will need to reconnect

Idle Time: set idle time, idle time at the appropriate time to release the PPPoE

Authentication: including local and Radius (Remote Authentication Dial In User)

Local User Management (CHAP Secrets)

Local User Management (CHAP Secrets)

| User | Password | IP Address | Enable |
|----------------------|----------------------|------------|--------------------------|
| <input type="text"/> | <input type="text"/> | 0.0.0.0 | <input type="checkbox"/> |

User: set PPPOE client's user name

Password: set PPPOE client's user password

IP Address: set PPPOE client's user IP address

Enable: enable or disable this setting

Radius

Radius Authentication

| | | |
|----------------------------|--|-----------------|
| Radius Server IP | <input type="text" value="192.168.1.1"/> | |
| Radius Authentication Port | <input type="text" value="1812"/> | (Default: 1812) |
| Radius Accounting Port | <input type="text" value="1813"/> | (Default: 1813) |
| Radius Shared Key | <input type="password" value="....."/> | |

Radius Server IP: set the Remote Authentication Dial In User-Server IP

Radius Authentication Port: set the Remote Authentication Dial in User-Authentication Port

Radius Accounting Port: set the Remote Authentication Dial in User-Accounting Port

Radius Shared Key: transactions between the client and RADIUS accounting server are authenticated through the use of a shared secret, which is never sent over the network.

3.3.4 VPN

3.3.4.1 PPTP

PPTP Server

PPTP Server

| | |
|-----------------------|---|
| PPTP Server | <input checked="" type="radio"/> Enable <input type="radio"/> Disable |
| Broadcast support | <input type="radio"/> Enable <input checked="" type="radio"/> Disable |
| Force MPPE Encryption | <input checked="" type="radio"/> Enable <input type="radio"/> Disable |
| DNS1 | <input type="text"/> |
| DNS2 | <input type="text"/> |
| WINS1 | <input type="text"/> |
| WINS2 | <input type="text"/> |
| Server IP | <input type="text"/> |
| Client IP(s) | <input type="text"/> |
| CHAP-Secrets | <input type="text"/> |

Broadcast support: enable or disable broadcast support of PPTP server

Force MPPE Encryption: enable or disable force MPPE encryption of PPTP data

DNS1/DNS2/WINS1/WINS2: set DNS1/DNS2/WINS1/WINS2

Server IP: input IP address of the router as PPTP server, differ from LAN address

Client IP(s): IP address assigns to the client, the format is xxx.xxx.xxx.xxx-xxx

CHAP Secrets: user name and password of the client using PPTP service

Note: client IP must be different with IP assigned by router DHCP.

The format of CHAP Secrets is user * password *.

PPTP Client

PPTP Client

PPTP Client Options Enable Disable

Server IP or DNS Name

Remote Subnet . . .

Remote Subnet Mask . . .

MPPE Encryption

MTU (Default: 1450)

MRU (Default: 1450)

NAT Enable Disable

User Name

Password Unmask

Server IP or DNS Name: PPTP server's IP Address or DNS Name

Remote Subnet: the network of the remote PPTP server

Remote Subnet Mask: subnet mask of remote PPTP server

MPPE Encryption: enable or disable Microsoft Point-to-Point Encryption.

MTU: maximum Transmission Unit

MRU: maximum Receive Unit

NAT: network Address Translation

User Name: user name to login PPTP Server.

Password: password to log into PPTP Server.

3.3.4.2 L2TP

L2TP Server

L2TP Server

| | |
|-----------------------|---|
| L2TP Server Options | <input checked="" type="radio"/> Enable <input type="radio"/> Disable |
| Force MPPE Encryption | <input checked="" type="radio"/> Enable <input type="radio"/> Disable |
| Server IP | <input type="text"/> |
| Client IP(s) | <input type="text"/> |
| CHAP-Secrets | <input type="text"/> |

Force MPPE Encryption: enable or disable force MPPE encryption of L2TP data

Server IP: input IP address of the router as PPTP server, differ from LAN address

Client IP(s): IP address assigns to the client, the format is xxx.xxx.xxx.xxx-xxx.xxx.xxx.xxx

CHAP Secrets: user name and password of the client using L2TP service

Note: client IP must be different with IP assigned by router DHCP.

The format of CHAP Secrets is user * password *.

L2TP Client

| | |
|------------------------|---|
| L2TP Client Options | <input checked="" type="radio"/> Enable <input type="radio"/> Disable |
| User Name | <input type="text" value="DOMAIN\\Username"/> |
| Password | <input type="text"/> <input type="checkbox"/> Unmask |
| Gateway (L2TP Server) | <input type="text"/> |
| Remote Subnet | <input type="text" value="0"/> . <input type="text" value="0"/> . <input type="text" value="0"/> . <input type="text" value="0"/> |
| Remote Subnet Mask | <input type="text" value="0"/> . <input type="text" value="0"/> . <input type="text" value="0"/> . <input type="text" value="0"/> |
| MPPE Encryption | <input type="text" value="mppe required"/> |
| MTU | <input type="text" value="1450"/> (Default: 1450) |
| MRU | <input type="text" value="1450"/> (Default: 1450) |
| NAT | <input checked="" type="radio"/> Enable <input type="radio"/> Disable |
| Require CHAP | <input checked="" type="radio"/> Yes <input type="radio"/> No |
| Refuse PAP | <input checked="" type="radio"/> Yes <input type="radio"/> No |
| Require Authentication | <input checked="" type="radio"/> Yes <input type="radio"/> No |

Gateway(L2TP Server): L2TP server's IP Address or DNS Name

Remote Subnet: the network of remote PPTP server

Remote Subnet Mask: subnet mask of remote PPTP server

MPPE Encryption: enable or disable Microsoft Point-to-Point Encryption

MTU: maximum transmission unit

MRU: maximum receive unit

Xiamen Four-Faith Communication Technology Co.,Ltd.

Page 51 of 90

Add: J1-J3,3rdFloor,No.44,GuanRiRoad,SoftWare Park,XiaMen .361008.China

http: //www.fourfaith.com Tel: +86 592-6300326 6300325 6300324 Fax: +86 592-5912735

NAT: network address translation

User Name: user name to login L2TP Server

Password: password to login L2TP Server

Require CHAP: enable or disable support chap authentication protocol

Refuse PAP: enable or disable refuse to support the pap authentication

Require Authentication: enable or disable support authentication protocol

3.3.4.3 OPENVPN

OPENVPN Server

Start Type WAN Up System

Start Type: WAN UP----start after on-line, System----start when boot up

Config via GUI Config File

Server mode Router (TUN) Bridge (TAP)

Config via: GUI----Page configuration, Config File----config File configuration

Server mode: Router (TUN)-route mode, Bridge (TAP)----bridge mode

Router (TUN):

Network

Netmask

Network: network address allowed by OPENVPN server

Netmask: netmask allowed by OPENVPN server

Bridge (TAP):

DHCP-Proxy mode Enable Disable

Pool start IP

Pool end IP

Gateway

Netmask

DHCP-Proxy mode: enable or disable DHCP-Proxy mode

Pool start IP: pool start IP of the client allowed by OPENVPN server

Pool end IP: pool end IP of the client allowed by OPENVPN server

Gateway: the gateway of the client allowed by OPENVPN server

Netmask: netmask of the client allowed by OPENVPN server

Port (Default: 1194)

Tunnel Protocol

Encryption Cipher

Hash Algorithm

Port: listen port of OPENVPN server

Tunnel Protocol: UCP or TCP of OPENVPN tunnel protocol

Encryption Cipher: Blowfish CBC, AES-128 CBC, AES-192 CBC, AES-256 CBC, AES-512 CBC

Hash Algorithm: Hash algorithm provides a method of quick access to data, including SHA1, SHA256, SHA512, MD5

Advanced Options

Advanced Options Enable Disable

Use LZO Compression Enable Disable

Redirect default Gateway Enable Disable

Allow Client to Client Enable Disable

Allow duplicate cn Enable Disable

TUN MTU Setting (Default: 1500)

MSS-Fix/Fragment across the tunnel (Default: Disable)

TLS Cipher

Client connect script

Use LZO Compression: enable or disable use LZO compression for data transfer

Redirect default Gateway: enable or disable redirect default gateway

Allow Client to Client: enable or disable allow client to client

Allow duplicate cn: enable or disable allow duplicate cn

TUN MTU Setting: set the value of TUN MTU

TCP MSS: MSS of TCP data

TLS Cipher: TLS (Transport Layer Security) encryption standard supports AES-128 SHA and AES-256 SHA

Client connect script: define some client script by user self

CA Cert

CA Cert: CA certificate

Public Server Cert

Public Server Cert: server certificate

Private Server Key

DH PEM

Private Server Key: the key seted by the server

DH PEM: PEM of the server

Additional Config

CCD-Dir DEFAULT file

TLS Auth Key

Certificate Revoke List

Additional Config: additional configurations of the server

CCD-Dir DEFAULT file: other file approaches

TLS Auth Key: authority key of Transport Layer Security

Certificate Revoke List: configure some revoke certificates

OPENVPN Client

Server IP/Name

Port (Default: 1194)

Tunnel Device

Tunnel Protocol

Encryption Cipher

Hash Algorithm

nsCertType verification

Server IP/Name: IP address or domain name of OPENVPN server

Port: listen port of OPENVPN client

Tunnel Device: TUN----Router mode, TAP----Bridge mode

Tunnel Protocol: UDP and TCP protocol

Encryption Cipher: Blowfish CBC, AES-128 CBC, AES-192 CBC, AES-256 CBC, AES-512 CBC

Hash Algorithm: Hash algorithm provides a method of quick access to data, including SHA1, SHA256, SHA512, MD5

nsCertType verification: support ns certificate type

| | | |
|------------------------------------|---|--|
| Advanced Options | <input checked="" type="radio"/> Enable | <input type="radio"/> Disable |
| Use LZO Compression | <input type="radio"/> Enable | <input checked="" type="radio"/> Disable |
| NAT | <input type="radio"/> Enable | <input checked="" type="radio"/> Disable |
| Bridge TAP to br0 | <input type="radio"/> Enable | <input checked="" type="radio"/> Disable |
| Local IP Address | <input type="text"/> | |
| TUN MTU Setting | <input type="text" value="1500"/> | (Default: 1500) |
| MSS-Fix/Fragment across the tunnel | <input type="text"/> | (Default: Disable) |
| TLS Cipher | <input type="text" value="Disable"/> | |
| TLS Auth Key | <input type="text"/> | |
| Additional Config | <input type="text"/> | |
| Policy based Routing | <input type="text"/> | |

Use LZO Compression: enable or disable use LZO compression for data transfer

NAT: enable or disable NAT through function

Bridge TAP to br0: enable or disable bridge TAP to br0

Local IP Address: set IP address of local OPENVPN client

TUN MTU Setting: set MTU value of the tunnel

TCP MSS: mss of TCP data

TLS Cipher: TLS (Transport Layer Security) encryption standard supports AES-128 SHA and AES-256 SHA

TLS Auth Key: authority key of Transport Layer Security

Additional Config: additional configurations of OPENVPN server

Policy based Routing: input some defined routing policy

| | |
|--------------------|----------------------|
| CA Cert | <input type="text"/> |
| Public Client Cert | <input type="text"/> |
| Private Client Key | <input type="text"/> |

CA Cert: CA certificate

Public Client Cert: client certificate

Private Client Key: client key

3.3.4.4 IPSEC

Connect Status and Control

Show IPSEC connection and status of current router on IPSEC page.

Connection status and control

| Name | Type | Common Name | status | Action |
|---------------------|------|-------------|--------|--------|
| Add | | | | |

Name: the name of IPSEC connection

Type: The type and function of current IPSEC connection

Common name: local subnet, local address, opposite end address and opposite end subnet of current connection

Status: connection status: closed, negotiating, establish

Closed: this connection does not launch a connection request to opposite end

Negotiating: this connection launch a request to opposite end, is under negotiating, the connection has not been established yet

Establish: the connection has been established, enabled to use this tunnel

Action: the action of this connection, current is to delete, edit, reconnect and enable

Delete: to delete the connection, also will delete IPSEC if IPSEC has set up

Edit: to edit the configure information of this connection, reload this connection to make the configuration effect after edit

Reconnect: this action will remove current tunnel, and re-launch tunnel establish request

Enable: when the connection is enable, it will launch tunnel establish request when the system reboot or reconnect, otherwise the connection will not do it

Add: to add a new IPSEC connection

Add IPSEC connection or edit IPSEC connection

Type: to choose IPSEC mode and relevant functions in this part, supports tunnel mode client, tunnel mode server and transfer mode currently

Type

| | |
|------------|--|
| Type | Net-to-Net Virtual Private Network |
| IPSEC role | <input checked="" type="radio"/> Client <input type="radio"/> Server |

Connection: this part contains basic address information of the tunnel

Connection

| | | | |
|---------------------|----------------------|---------------------|-------------------------------------|
| Name | <input type="text"/> | Enabled | <input checked="" type="checkbox"/> |
| Local WAN Interface | vlan1 | Remote Host address | <input type="text"/> |
| Local Subnet | <input type="text"/> | Remote subnet | <input type="text"/> |
| Local Id | <input type="text"/> | Remote ID | <input type="text"/> |

Name: to indicate this connection name, must be unique

Enabled: If enable, the connection will send tunnel connection request when it is reboot or re-connection, otherwise it is no need if disable

Local WAN Interface: local addresss of the tunnel

Remote Host Address: IP/domain name of end opposite; this option can not fill in if using tunnel mode server

Local Subnet: IPsec local protects subnet and subnet mask, i.e. 192.168.1.0/24; this option can not fill in if using transfer mode

Remote Subnet: IPsec opposite end protects subnet and subnet mask, i.e.192.168.7.0/24; this option can not fill in if using transfer mode

Local ID: tunnel local end identification, IP and domain name are available

Remote ID: tunnel opposite end identification, IP and domain name are available

Detection: this part contains configure information of connection detection

Detection

| | |
|-----------------------------|-------------------------------------|
| Enable DPD Detection | <input checked="" type="checkbox"/> |
| Time Interval | 60 (S) |
| Timeout | 60 (S) |
| Action | hold |
| Enable Connection Detection | <input checked="" type="checkbox"/> |

Enable DPD Detection: enable or disable this function, tick means enable

Time Interval: set time interval of connect detection (DPD)

Timeout: set the timeout of connect detection

Action: set the action of connect detection

Advanced Settings: this part contains relevant setting of IKE, ESP, negotiation mode, etc.

Advanced Settings

Enable advanced settings

IKE Encryption IKE Integrity IKE Groupype

IKE Lifetime hours

ESP Encryption ESP Integrity

ESP Keylife hours

IKE+ESP: Use only proposed settings.

IKE aggressive mode allowed. Avoid if possible (preshared key is transmitted in clear text)!

Perfect Forward Secrecy (PFS)

Negotiate payload compression

Enable Advanced Settings: enable to configure 1st and 2nd phase information, otherwise it will automatic negotiation according to opposite end

IKE Encryption: IKE phased encryption mode

IKE Integrity: IKE phased integrity solution

IKE Groupype: DH exchange algorithm

IKE Lifetime: set IKE lifetime, current unit is hour, the default is 0

ESP Encryption: ESP encryption type

ESP Integrity: ESP integrity solution

ESP Keylife: set ESP keylife, current unit is hour, the default is 0

IKE aggressive mode allowed: negotiation mode adopt aggressive mode if tick; it is main mode if non-tick

Negotiate payload compression: Tick to enable PFS, non-tick to diable PFS

Authentication: choose use share encryption option or certificate authentication option. Current is only to choose use share encryption option.

Authentication

Use a Pre-Shared Key:

Generate and use the X.509 certificate

3.3.4.5 GRE

GRE (Generic Routing Encapsulation, Generic Routing Encapsulation) protocol is a network layer protocol (such as IP and IPX) data packets are encapsulated, so these encapsulated data packets to another network layer protocol (IP)transmission. GRE Tunnel (tunnel) technology, Layer Two Tunneling Protocol VPN (Virtual Private Network).

GRE Tunnel

GRE Tunnel Enable Disable

GRE Tunnel: enable or disable GRE function

| | | |
|------------------|---|---------------------------------------|
| Number | <input type="text" value="1 (fff)"/> | <input type="button" value="Delete"/> |
| Status | <input type="text" value="Enable"/> | |
| Name | <input type="text" value="fff"/> | |
| Through | <input type="text" value="PPP"/> | |
| Peer Wan IP Addr | <input type="text" value="120.42.46.98"/> | |
| Peer Subnet | <input type="text" value="192.168.5.0/24"/> | (eg:192.168.1.0/24) |
| Peer Tunnel IP | <input type="text" value="200.200.200.1"/> | |
| Local Tunnel IP | <input type="text" value="200.200.200.5"/> | |
| Local Netmask | <input type="text" value="255.255.255.0"/> | |

Number: Switch on/off GRE tunnel app

Status: Switch on/off someone GRE tunnel app

Name: GRE tunnel name

Through: The GRE packet transmit interface

Peer Wan IP Addr: The remote WAN address

Peer Subnet: The remote gateway local subnet, eg: 192.168.1.0/24

Peer Tunnel IP: The remote tunnel ip address

Local Tunnel IP: The local tunnel ip address

Local Netmask: Netmask of local network

| | |
|-------------|---|
| Keepalive | <input checked="" type="radio"/> Enable <input type="radio"/> Disable |
| Retry times | <input type="text"/> |
| Interval | <input type="text"/> |
| Fail Action | <input type="text" value="Hold"/> |

Keepalive: Enable or disable GRE Keepalive function

Retry times: GRE keepalive detect fail retries

Interval: The time interval of GRE keepalive packet sent

Fail Action: The action would be exec after keeping alive failed

Click on “**View GRE tunnels**” keys can view the information of GRE

GRE Tunnels list

| Number | Name | Enable | Through | Peer Wan IP Addr | Peer Subnet | Peer Tunnel IP | Local Tunnel IP | Local Netmask | Keepalive | Retry times | Interval | Fail Action |
|--------|------|--------|---------|------------------|----------------|----------------|-----------------|---------------|-----------|-------------|----------|-------------|
| 1 | fff | Yes | PPP | 120.42.46.98 | 192.168.5.0/24 | 200.200.200.1 | 200.200.200.5 | 255.255.255.0 | No | 0 | 0 | Hold |

3.3.5 Security

3.3.5.1 Firewall

You can enable or disable the firewall, filter specific Internet data types, and prevent anonymous Internet requests, ultimately enhance network security.

Firewall Protection

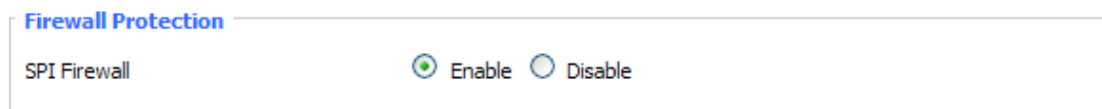

Firewall enhance network security and use SPI to check the packets into the network. To use firewall protection, choose to enable otherwise disabled. Only enable the SPI firewall, you can use other firewall functions: filtering proxy, block WAN requests, etc.

Additional Filters

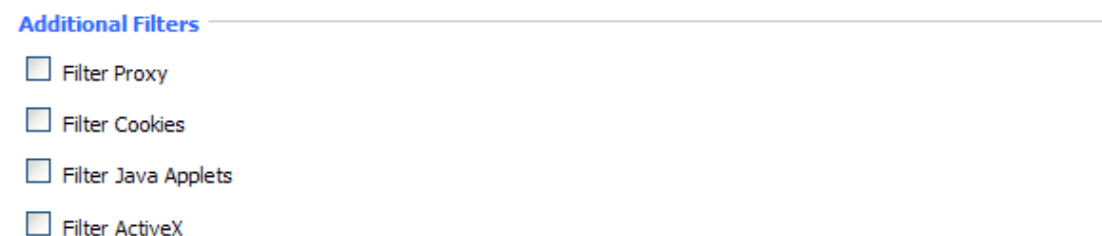

Filter Proxy: Wan proxy server may reduce the security of the gateway, Filtering Proxy will refuse any access to any wan proxy server. Click the check box to enable the function otherwise disabled.

Filter Cookies: Cookies are the website of data the data stored on your computer. When you interact with the site, the cookies will be used. Click the check box to enable the function otherwise disabled.

Filter Java Applets: If refuse to Java, you may not be able to open web pages using the Java programming. Click the check box to enable the function otherwise disabled.

Filter ActiveX: If refuse to ActiveX, you may not be able to open web pages using the ActiveX programming. Click the check box to enable the function otherwise disabled.

Prevent WAN Request

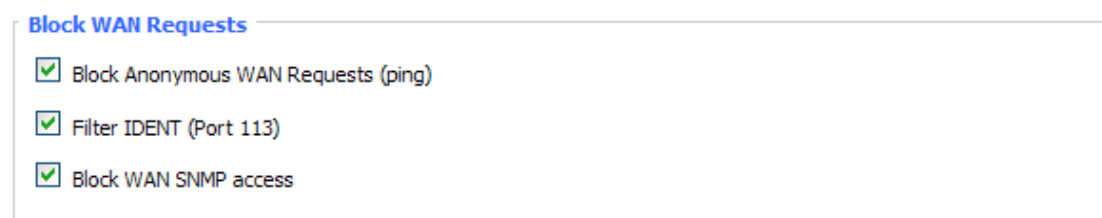

Block Anonymous WAN Requests (ping): By selecting “Block Anonymous WAN Requests (ping)” box to enable this feature, you can prevent your network from the Ping or detection of other Internet users. so that make More difficult to break into your network. The default state of

this feature is enabled ,choose to disable allow anonymous Internet requests.

Filter IDENT (Port 113): Enable this feature can prevent port 113 from being scanned from outside. Click the check box to enable the function otherwise disabled.

Block WAN SNMP access: This feature prevents the SNMP connection requests from the WAN. After Complete the changes, click the **Save Settings** button to save your changes. Click the **Cancel Changes** button to cancel unsaved changes.

Impede WAN DoS/Bruteforce

Impede WAN DoS/Bruteforce

- Limit SSH Access
- Limit Telnet Access
- Limit PPTP Server Access
- Limit L2TP Server Access

Limit ssh Access: This feature limits the access request from the WAN by ssh, and per minute up to accept two connection requests on the same IP. Any new access request will be automatically dropped.

Limit Telnet Access: This feature limits the access request from the WAN by Telnet, and per minute up to accept two connection requests on the same IP. Any new access request will be automatically dropped.

Limit PPTP Server Access: When build a PPTP Server in the router,this feature limits the access request from the WAN by ssh, and per minute up to accept two connection requests on the same IP . Any new access request will be automatically dropped.

Limit L2TP Server Access: When build a L2TP Server in the router, this feature limits the access request from the WAN by ssh, and per minute up to accept two connection requests on the same IP. Any new access request will be automatically dropped.

Log Management

The router can keep logs of all incoming or outgoing traffic for your Internet connection.

Log

Log Enable Disable

Log: To keep activity logs, select Enable. To stop logging, select Disable. When select enable, the following page will appear.

Log

Log Enable Disable

Log Level ▾

Options

Dropped ▾

Rejected ▾

Accepted ▾

Log Level: Set this to the required log level. Set Log Level higher to log more actions.

Options: When select Enable above 3 options separately, the corresponding connection will be recorded in the journal, if select disabled, they will not be recorded.

Incoming Log: To see a temporary log of the Router's most recent incoming traffic, click the Incoming Log button.

Incoming Log Table

| Source IP | Protocol | Destination Port Number | Rule |
|---|----------|-------------------------|------|
| <input type="button" value="Refresh"/> <input type="button" value="Close"/> | | | |

Outgoing Log: To see a temporary log of the Router's most recent outgoing traffic, click the Outgoing Log button.

Outgoing Log Table

| LAN IP | Destination URL/IP | Protocol | Service/Port Number | Rule |
|---------------|--------------------|----------|---------------------|----------|
| 192.168.1.164 | 223.203.188.56 | TCP | www | Accepted |
| 192.168.1.164 | 183.60.16.200 | UDP | 8000 | Accepted |
| 192.168.1.164 | 183.60.48.60 | UDP | 8000 | Accepted |
| 192.168.1.164 | 112.95.240.183 | UDP | 8000 | Accepted |
| 192.168.1.164 | 183.60.49.245 | UDP | 8000 | Accepted |
| 192.168.1.164 | 119.147.32.204 | UDP | 8000 | Accepted |
| 192.168.1.164 | 112.90.86.244 | UDP | 8000 | Accepted |
| 192.168.1.164 | 119.147.45.157 | UDP | 8000 | Accepted |
| 192.168.1.164 | 183.60.49.15 | UDP | 8000 | Accepted |
| 192.168.1.164 | 183.60.16.70 | UDP | 8000 | Accepted |
| 192.168.1.164 | 183.60.16.200 | UDP | 8000 | Accepted |
| 192.168.1.164 | 183.60.48.60 | UDP | 8000 | Accepted |

Click the **Save Settings** button to save your changes. Click the **Cancel Changes** button to cancel unsaved changes.

3.3.5.2 VPN Passthrough

Virtual Private Networking (VPN) is typically used for work-related networking. For VPN tunnels, the router supports OPENVPN Passthrough, PPTP Passthrough and L2TP Passthrough.

Virtual Private Network (VPN)

VPN Passthrough

| | | |
|-------------------|---|-------------------------------|
| IPSec Passthrough | <input checked="" type="radio"/> Enable | <input type="radio"/> Disable |
| PPTP Passthrough | <input checked="" type="radio"/> Enable | <input type="radio"/> Disable |
| L2TP Passthrough | <input checked="" type="radio"/> Enable | <input type="radio"/> Disable |

IPSec Passthrough: Internet Protocol Security (IPSec) is a suite of protocols used to implement secure exchange of packets at the IP layer. To allow IPSec tunnels to pass through the router, IPSec Passthrough is enabled by default. To disable IPSec Passthrough, select Disable.

PPTP Passthrough: Point-to-Point Tunneling Protocol is the method used to enable VPN sessions to a Windows NT 4.0 or 2000 server. To allow PPTP tunnels to pass through the router, PPTP Passthrough is enabled by default. To disable PPTP Passthrough, select Disable.

L2TP Passthrough: Layer Two (2) Tunneling Protocol, an extension to the PPP protocol that enables ISPs to operate Virtual Private Networks (VPNs). L2TP merges the best features of two other tunneling protocols: PPTP from Microsoft and L2F from Cisco Systems. To allow L2TP tunnels to pass through the router, L2TP Passthrough is enabled by default. To disable L2TP Passthrough, select Disable.

Click the **Save Settings** button to save your changes. Click the **Cancel Changes** button to cancel unsaved changes.

3.3.6 Access Restrictions

3.3.6.1 WAN Access

Use access restrictions, you can block or allow specific types of Internet applications. You can set specific PC-based Internet access policies. This feature allows you to customize up to ten different Internet Access Policies for particular PCs, which are identified by their IP or MAC addresses.

Access Policy

| | | | |
|---|---|--|---------|
| Policy | 1 () | Delete | Summary |
| Status | <input type="radio"/> Enable | <input checked="" type="radio"/> Disable | |
| Policy Name | <input type="text"/> | | |
| PCs | Edit List of clients | | |
| <input type="radio"/> Deny | Internet access during selected days and hours. | | |
| <input checked="" type="radio"/> Filter | | | |

Two options in the default policy rules: "Filter" and "reject". If select "Deny", you will deny specific computers to access any Internet service at a particular time period. If you choose to

"filter", It will block specific computers to access the specific sites at a specific time period. You can set up 10 Internet access policies filtering specific PCs access Internet services at a particular time period.

Access Policy: You may define up to 10 access policies. Click Delete to delete a policy or Summary to see a summary of the policy.

Status: Enable or disable a policy.

Policy Name: You may assign a name to your policy.

PCs: The part is used to edit client list, the strategy is only effective for the PC in the list.

Days

| | | | | | | | |
|-------------------------------------|--------------------------|--------------------------|--------------------------|--------------------------|--------------------------|--------------------------|--------------------------|
| Everyday | Sun | Mon | Tue | Wed | Thu | Fri | Sat |
| <input checked="" type="checkbox"/> | <input type="checkbox"/> | <input type="checkbox"/> | <input type="checkbox"/> | <input type="checkbox"/> | <input type="checkbox"/> | <input type="checkbox"/> | <input type="checkbox"/> |

Times

24 Hours

From 0 : 00 To 0 : 00

Days: Choose the day of the week you would like your policy to be applied.

Times: Enter the time of the day you would like your policy to be applied.

Website Blocking by URL Address

| | | |
|----------------------|----------------------|----------------------|
| <input type="text"/> | <input type="text"/> | <input type="text"/> |
| <input type="text"/> | <input type="text"/> | <input type="text"/> |
| <input type="text"/> | <input type="text"/> | <input type="text"/> |

Website Blocking by Keyword

| | | | |
|----------------------|----------------------|----------------------|----------------------|
| <input type="text"/> | <input type="text"/> | <input type="text"/> | <input type="text"/> |
| <input type="text"/> | <input type="text"/> | <input type="text"/> | <input type="text"/> |

Website Blocking by URL Address: You can block access to certain websites by entering their URL.

Website Blocking by Keyword: You can block access to certain website by the keywords contained in their webpage

| List of clients | |
|--|---|
| Enter MAC Address of the clients in this format: xx:xx:xx:xx:xx:xx | |
| MAC 01 | <input type="text" value="00:AA:BB:CC:DD:EE"/> |
| MAC 02 | <input type="text" value="00:00:00:00:00:00"/> |
| MAC 03 | <input type="text" value="00:00:00:00:00:00"/> |
| MAC 04 | <input type="text" value="00:00:00:00:00:00"/> |
| MAC 05 | <input type="text" value="00:00:00:00:00:00"/> |
| MAC 06 | <input type="text" value="00:00:00:00:00:00"/> |
| MAC 07 | <input type="text" value="00:00:00:00:00:00"/> |
| MAC 08 | <input type="text" value="00:00:00:00:00:00"/> |
| Enter the IP Address of the clients | |
| IP 01 | 192.168.1. <input type="text" value="15"/> |
| IP 02 | 192.168.1. <input type="text" value="0"/> |
| IP 03 | 192.168.1. <input type="text" value="0"/> |
| IP 04 | 192.168.1. <input type="text" value="0"/> |
| IP 05 | 192.168.1. <input type="text" value="0"/> |
| IP 06 | 192.168.1. <input type="text" value="0"/> |
| Enter the IP Range of the clients | |
| IP Range 01 | <input type="text" value="192"/> . <input type="text" value="168"/> . <input type="text" value="1"/> . <input type="text" value="19"/> ~ <input type="text" value="192"/> . <input type="text" value="168"/> . <input type="text" value="1"/> . <input type="text" value="30"/> |
| IP Range 02 | <input type="text" value="0"/> . <input type="text" value="0"/> . <input type="text" value="0"/> . <input type="text" value="0"/> ~ <input type="text" value="0"/> . <input type="text" value="0"/> . <input type="text" value="0"/> . <input type="text" value="0"/> |

set up Internet access policy

1. Select the policy number (1-10) in the drop-down menu.
2. For this policy is enabled, click the radio button next to "Enable"
3. Enter a name in the Policy Name field.
4. Click the Edit List of PCs button.
5. On the List of PCs screen, specify PCs by IP address or MAC address. Enter the appropriate IP addresses into the IP fields. If you have a range of IP addresses to filter, complete the appropriate IP Range fields. Enter the appropriate MAC addresses into the MAC fields.
6. Click the Apply button to save your changes. Click the Cancel button to cancel your unsaved changes. Click the Close button to return to the Filters screen.
7. If you want to block the listed PCs from Internet access during the designated days and time, then keep the default setting, Deny. If you want the listed PCs to have Internet filtered during the designated days and time, then click the radio button next to Filter.
8. Set the days when access will be filtered. Select Everyday or the appropriate days of the week.
9. Set the time when access will be filtered. Select 24 Hours, or check the box next to From and

use the drop-down boxes to designate a specific time period.

10. Click the Add to Policy button to save your changes and active it.
11. To create or edit additional policies, repeat steps 1-9.
12. To delete an Internet Access Policy, select the policy number, and click the Delete button.

Note:

- 1) The default factory value of policy rules is "filtered". If the user chooses the default policy rules for "refuse", and editing strategies to save or directly to save the settings. If the strategy edited is the first, it will be automatically saved into the second, if not the first, keep the original number.
- 2) Turn off the power of the router or reboot the router can cause a temporary failure。 After the failure of the router, if can not automatically synchronized NTP time server, you need to recalibrate to ensure the correct implementation of the relevant period control function.

3.3.6.2 Packet Filter

To block some packets getting Internet access or block some Internet packets getting local network access, you can configure filter items to block these packets.

Packet Filter

Packet filter function is realized based on IP address or port of packets.

Enable Packet Filter Enable Disable

Policy ▼

Enable Packet Filter: Enable or disable “packet filter” function

Policy: The filter rule’s policy, you can choose the following options

Discard The Following--Discard packets conform to the following rules, Accept all other packets

Only Accept The Following-- Accept only the data packets conform to the following rules, Discard all other packets

Add Filter Rule

Direction ▼

Protocol ▼

Source Ports -

Destination Ports -

Source IP . . . /

Destination IP . . . /

Direction

input: packet from WAN to LAN

output: packet from LAN to WAN

Protocol: packet protocol type

Source Ports: packet's source port

Destination Ports: packet's destination port

Source IP: packet's source IP address

Destination IP: packet's destination IP address

Note: "Source Port" , "Destination Port" , "Source IP" , "Destination IP" could not be all empty ,you have to input at least one of these four parameters.

3.3.7 NAT

3.3.7.1 Port Forwarding

Port Forwarding allows you to set up public services on your network, such as web servers, ftp servers, e-mail servers, or other specialized Internet applications. Specialized Internet applications are any applications that use Internet access to perform functions such as videoconferencing or online gaming. When users send this type of request to your network via the Internet, the router will forward those requests to the appropriate PC. If you want to forward a whole range of ports, see [Port Range Forwarding](#).

Forwards

| Application | Protocol | Source Net | Port from | IP Address | Port to | Enable |
|-------------|----------|--------------|-----------|--------------|---------|-------------------------------------|
| web | TCP | 192.168.8.11 | 8000 | 192.168.1.12 | 80 | <input checked="" type="checkbox"/> |
| ftp | Both | 192.168.8.12 | 24 | 192.168.1.12 | 21 | <input checked="" type="checkbox"/> |

Application: Enter the name of the application in the field provided.

Protocol: Chose the right protocol TCP,UDP or Both. Set this to what the application requires.

Source Net: Forward only if sender matches this ip/net (example 192.168.1.0/24).

Port from: Enter the number of the external port (the port number seen by users on the Internet).

IP Address: Enter the IP Address of the PC running the application.

Port to: Enter the number of the internal port (the port number used by the application).

Enable: Click the Enable checkbox to enable port forwarding for the application.

Check all values and click **Save Settings** to save your settings. Click the **Cancel changes** button to cancel your unsaved changes.

3.3.7.2 Port Range Forward

Port Range Forwarding allows you to set up public services on your network, such as web

servers, ftp servers, e-mail servers, or other specialized Internet applications. Specialized Internet applications are any applications that use Internet access to perform functions such as videoconferencing or online gaming. When users send this type of request to your network via the Internet, the router will forward those requests to the appropriate PC. If you only want to forward a single port, see [Port Forwarding](#).

Port Range Forward

Forwards

| Application | Start | End | Protocol | IP Address | Enable |
|-------------|-------|-------|----------|--------------|-------------------------------------|
| web-tftp | 800 | 8100 | Both | 192.168.1.16 | <input checked="" type="checkbox"/> |
| game | 9000 | 10000 | Both | 192.168.1.16 | <input checked="" type="checkbox"/> |

Add Remove

Application: Enter the name of the application in the field provided.

Start: Enter the number of the first port of the range you want to seen by users on the Internet and forwarded to your PC.

End: Enter the number of the last port of the range you want to seen by users on the Internet and forwarded to your PC.

Protocol: Chose the right protocol TCP,UDP or Both. Set this to what the application requires.

IP Address: Enter the IP Address of the PC running the application.

Enable: Click the Enable checkbox to enable port forwarding for the application.

Check all values and click **Save Settings** to save your settings. Click the **Cancel changes** button to cancel your unsaved changes.

3.3.7.3 Port Triggering

Port Triggering allows you to do port forwarding without setting a fixed PC. By setting Port Triggering rules, you can allow inbound traffic to arrive at a specific LAN host, using ports different than those used for the outbound traffic. This is called port triggering since the outbound traffic triggers to which ports inbound traffic is directed.

Port Triggering

Forwards

| Application | Triggered Port Range | | Protocol | Forwarded Port Range | | Enable |
|-------------|----------------------|-------|----------|----------------------|-----|-------------------------------------|
| | Start | End | | Start | End | |
| web | 8000 | 10000 | Both | 20 | 800 | <input checked="" type="checkbox"/> |

Add Remove

If you want to forward ports to a PC with a static IP address, see [Port Forwarding](#) or [Port Range Forwarding](#).

Application: Enter the name of the application in the field provided.

Triggered Port Range: Enter the number of the first and the last port of the range, which should

be triggered. If a PC sends outbound traffic from those ports, incoming traffic on the Forwarded Range will be forwarded to that PC.

Forwarded Port Range: Enter the number of the first and the last port of the range, which should be forwarded from the Internet to the PC, which has triggered the Triggered Range.

Enable :Click the Enable checkbox to enable port triggering for the application.

Check all values and click Save Settings to save your settings. Click the Cancel changes button to cancel your unsaved changes.

3.3.7.4 DMZ

The DMZ (DeMilitarized Zone) hosting feature allows one local user to be exposed to the Internet for use of a special-purpose service such as Internet gaming or videoconferencing. DMZ hosting forwards all the ports at the same time to one PC. The Port Forwarding feature is more secure because it only opens the ports you want to have opened, while DMZ hosting opens all the ports of one computer, exposing the computer so the Internet can see it.

Demilitarized Zone (DMZ)

DMZ

Use DMZ Enable Disable

DMZ Host IP Address 192.168.8.

Any PC whose port is being forwarded must should have a new static IP address assigned to it because its IP address may change when using the DHCP function.

DMZ Host IP Address: To expose one PC to the Internet, select Enable and enter the computer's IP address in the DMZ Host IP Address field. To disable the DMZ, keep the default setting : Disable

Check all values and click **Save Settings** to save your settings. Click the **Cancel changes** button to cancel your unsaved changes.

3.3.8 QoS Setting

3.3.8.1 Basic

Bandwidth management prioritizes the traffic on your router. Interactive traffic (telephony, browsing, telnet, etc.) gets priority and bulk traffic (file transfer, P2P) gets low priority. The main goal is to allow both types to live side-by side without unimportant traffic disturbing more critical things. All of this is more or less automatic.

QoS allows control of the bandwidth allocation to different services, netmasks, MAC addresses and the four LAN ports.

Main WAN QoS Settings

| | |
|------------------|---|
| Start QoS | <input type="radio"/> Enable <input checked="" type="radio"/> Disable |
| Port | WAN |
| Packet Scheduler | HTB |
| Uplink (kbps) | 0 |
| Downlink (kbps) | 0 |

Bkup WAN QoS Settings

| | |
|------------------|---|
| Start QoS | <input type="radio"/> Enable <input checked="" type="radio"/> Disable |
| Port | WAN |
| Packet Scheduler | HTB |
| Uplink (kbps) | 0 |
| Downlink (kbps) | 0 |

Uplink (kbps): In order to use bandwidth management (QoS) you must enter bandwidth values for your uplink. These are generally 80% to 90% of your maximum bandwidth.

Downlink (kbps): In order to use bandwidth management (QoS) you must enter bandwidth values for your downlink. These are generally 80% to 90% of your maximum bandwidth.

3.3.8.2 Classify

Netmask Priority

Netmask Priority

| Delete | IP/Mask | Priority |
|--------------------------|--|----------|
| <input type="checkbox"/> | 192.168.1.1/24 | Exempt |
| <input type="checkbox"/> | 192.168.2.3/24 | Standard |
| <input type="checkbox"/> | 192.168.3.4/32 | Express |
| <input type="checkbox"/> | 192.168.4.5/32 | Bulk |
| | <input type="button" value="Add"/> <input type="text" value="0"/> <input type="text" value="0"/> <input type="text" value="0"/> <input type="text" value="0"/> <input type="text" value="0"/> / <input type="text" value="0"/> | |

You may specify priority for all traffic from a given IP address or IP Range.

Check all values and click **Save Settings** to save your settings. Click the **Cancel changes** button to cancel your unsaved changes.

3.3.9 Applications

3.3.9.1 Serial Applications

Xiamen Four-Faith Communication Technology Co.,Ltd.

Page 70 of 90

Add: J1-J3,3rdFloor,No.44,GuanRiRoad,SoftWare Park,XiaMen .361008.China

http: //www.fourfaith.com Tel: +86 592-6300326 6300325 6300324 Fax: +86 592-5912735

There is a console port on Four-Faith router. Normally, this port is used to debug the router. This port can also be used as a serial port. The router has embedded a serial to TCP program. The data sent to the serial port is encapsulated by TCP/IP protocol stack and then is sent to the destination server. This function can work as a Four-Faith DTU (Data Terminal Unit). Please refer www.four-faith.com for more information about this product.

Serial Applications

Serial Applications Enable Disable

Baudrate

Databit

Stopbit

Parity

Flow Control

Protocol

Server Address

Server Port

Device Number

Device Id

Heartbeat Interval

Baudrate: The serial port's baudrate

Databit: The serial port's databit

Parity: The serial port's parity

Stopbit: The serial port's stopbit

Flow Control: The serial port's flow control type.

Enable Serial TCP Function: Enable the serial to TCP function

Protocol Type: The protocol type to transmit data.

UDP(DTU) – Data transmit with UDP protocol , work as a Four-Faith DTU which has application protocol and hear beat mechanism.

Pure UDP – Data transmit with standard UDP protocol.

TCP(DTU) -- Data transmit with TCP protocol , work as a Four-Faith DTU which has application protocol and hear beat mechanism.

Pure TCP -- Data transmit with standard TCP protocol, router is the client.

TCP Server -- Data transmit with standard TCP protocol, router is the server.

TCST -- Data transmit with TCP protocol, Using a custom data

Server Address: The data service center's IP Address or domain name.

Server Port: The data service center's listening port.

Device ID: The router's identity ID.

Device Number: The router's phone number.

Heartbeat Interval: The time interval to send heart beat packet. This item is valid only when you choose UDP(DTU) or TCP(DTU) protocol type.

TCP Server Listen Port: This item is valid when Protocol Type is “TCP Server”

Custom Heartbeat Packet : This item is valid when Protocol Type is “TCST”

Custom Registration Packets: This item is valid when Protocol Type is “TCST”

3.3.10 Administration

3.3.10.1 Management

The Management screen allows you to change the router's settings. On this page you will find most of the configurable items of the router code.

Router Password

| | |
|---------------------|--------------------------|
| Router Username | <input type="password"/> |
| Router Password | <input type="password"/> |
| Re-enter to confirm | <input type="password"/> |

The new password must not exceed 32 characters in length and must not include any spaces. Enter the new password a second time to confirm it.

Note:

Default username is admin.

It is strongly recommended that you change the factory default password of the router, which is admin. All users who try to access the router's web-based utility or Setup Wizard will be prompted for the router's password.

Web Access

This feature allows you to manage the router using either HTTP protocol or the HTTPS protocol. If you choose to disable this feature, a manual reboot will be required. You can also activate or not the router information web page. It's now possible to password protect this page (same username and password than above).

Web Access

| | |
|-------------------------------|---|
| Protocol | <input checked="" type="checkbox"/> HTTP <input type="checkbox"/> HTTPS |
| Auto-Refresh (in seconds) | <input type="text" value="3"/> |
| Enable Info Site | <input checked="" type="radio"/> Enable <input type="radio"/> Disable |
| Info Site Password Protection | <input type="checkbox"/> Enabled |

Protocol: This feature allows you to manage the router using either HTTP protocol or the HTTPS protocol

Auto-Refresh: Adjusts the Web GUI automatic refresh interval. 0 disables this feature completely

Enable Info Site: Enable or disable the login system information page

Info Site Password Protection: Enable or disable the password protection feature of the system information page

Remote Access

| | | |
|--------------------|---|-----------------------------------|
| Web GUI Management | <input checked="" type="radio"/> Enable <input type="radio"/> Disable | |
| Use HTTPS | <input type="checkbox"/> | |
| Web GUI Port | <input type="text" value="8080"/> | (Default: 8080, Range: 1 - 65535) |
| SSH Management | <input checked="" type="radio"/> Enable <input type="radio"/> Disable | |
| SSH Remote Port | <input type="text" value="22"/> | (Default: 22, Range: 1 - 65535) |
| Telnet Management | <input type="radio"/> Enable <input checked="" type="radio"/> Disable | |

Remote Access: This feature allows you to manage the router from a remote location, via the Internet. To disable this feature, keep the default setting, Disable. To enable this feature, select Enable, and use the specified port (default is 8080) on your PC to remotely manage the router. You must also change the router's default password to one of your own, if you haven't already.

To remotely manage the router, enter `http://xxx.xxx.xxx.xxx:8080` (the x's represent the router's Internet IP address, and 8080 represents the specified port) in your web browser's address field. You will be asked for the router's password.

If you use https you need to specify the url as `https://xxx.xxx.xxx.xxx:8080` (not all firmwares does support this without rebuilding with SSL support).

SSH Management: You can also enable SSH to remotely access the router by Secure Shell. Note that SSH daemon needs to be enable in Services page.

Note:

If the Remote Router Access feature is enabled, anyone who knows the router's Internet IP address and password will be able to alter the router's settings.

Telnet Management: Enable or disable remote Telnet function

Cron

| | |
|----------------------|---|
| Cron | <input checked="" type="radio"/> Enable <input type="radio"/> Disable |
| Additional Cron Jobs | <input type="text"/> |

Cron: The cron subsystem schedules execution of Linux commands. You'll need to use the command line or startup scripts to actually use this.

Language Selection

| | |
|----------|--------------------------------------|
| Language | <input type="text" value="English"/> |
|----------|--------------------------------------|

Language: Set up the router page shows the type of language, including simplified Chinese and English.

3.3.10.2 Keep Alive

Schedule Reboot

Schedule Reboot

Schedule Reboot Enable Disable

Interval (in seconds)

At a set Time :

You can schedule regular reboots for the router :

Regularly after xxx seconds.

At a specific date time each week or everyday.

Note:

For date based reboots Cron must be activated. See Management for Cron activation.

3.3.10.3 Commands

Commands: You are able to run command lines directly via the Webinterface.

Command Shell

Commands

Run Command: You can run command lines via the web interface. Fill the text area with your command and click Run Commands to submit.

Startup: You can save some command lines to be executed at startup's router. Fill the text area with commands (only one command by row) and click Save Startup.

Shutdown: You can save some command lines to be executed at shutdown's router. Fill the text area with commands (only one command by row) and click Save Shutdown.

Firewall: Each time the firewall is started, it can run some custom iptables instructions. Fill the text area with firewall's instructions (only one command by row) and click Save Firewall.

Custom Script: Custom script is stored in /tmp/custom.sh file. You can run it manually or use cron to call it. Fill the text area with script's instructions (only one command by row) and click Save Custom Script.

3.3.10.4 Factory Defaults

Xiamen Four-Faith Communication Technology Co.,Ltd.

Page 74 of 90

Add: J1-J3,3rdFloor,No.44,GuanRiRoad,SoftWare Park,XiaMen .361008.China

http: //www.fourfaith.com Tel: +86 592-6300326 6300325 6300324 Fax: +86 592-5912735

Factory Defaults

Reset router settings

Restore Factory Defaults Yes No

Reset router settings: Click the Yes button to reset all configuration settings to their default values. Then click the Apply Settings button.

Note:

Any settings you have saved will be lost when the default settings are restored. After restoring the router is accessible under the default IP address 192.168.1.1 and the default password admin.

3.3.10.5 Firmware Upgrade

Firmware Upgrade

After flashing, reset to

Firmware Upgrade: New firmware versions are posted at www.four-faith.com and can be downloaded. If the Router is not experiencing difficulties, then there is no need to download a more recent firmware version, unless that version has a new feature that you want to use.

Note:

When you upgrade the Router's firmware, you lose its configuration settings, so make sure you write down the Router settings before you upgrade its firmware.

To upgrade the Router's firmware:

1. Download the firmware upgrade file from the website.
2. Click the Browse... button and chose the firmware upgrade file.
3. Click the Upgrade button and wait until the upgrade is finished.

Note:

Upgrading firmware may take a few minutes.

Do not turn off the power or press the reset button!

After flashing, reset to: If you want to reset the router to the default settings for the firmware version you are upgrading to, click the Firmware Defaults option.

3.3.10.6 Backup

Backup Configuration

Backup Settings

Click the "Backup" button to download the configuration backup file to your computer.

Restore Configuration

Restore Settings

Please select a file to restore

WARNING

Only upload files backed up using this firmware and from the same model of router.
Do not upload any files that were not created by this interface!

Backup Settings: You may backup your current configuration in case you need to reset the router back to its factory default settings. Click the Backup button to backup your current configuration.

Restore Settings: Click the Browse... button to browse for a configuration file that is currently saved on your PC. Click the Restore button to overwrite all current configurations with the ones in the configuration file.

Note:

Only restore configurations with files backed up using the same firmware and the same model of router.

3.3.11 Status

3.3.11.1 Router

System

| | |
|------------------|--------------------------------------|
| Router Name | Four-Faith |
| Router Model | Four-Faith Router |
| Firmware Version | FXXXX v1.0 (01/10/12) std - build 94 |
| MAC Address | <u>00:AA:BB:CC:DD:44</u> |
| Host Name | |
| WAN Domain Name | |
| LAN Domain Name | |
| Current Time | Sat, 01 Jan 2000 00:51:29 |
| Uptime | 51 min, |

Router Name: name of the router, setting→basic setting to modify

Router Model: model of the router, unavailable to modify

Firmware Version: software version information

MAC Address: MAC address of WAN, setting→Clone MAC Address to modify

Host Name: host name of the router, setting→basic setting to modify

WAN Domain Name: domain name of WAN, setting→basic setting to modify

LAN Domain Name: domain name of LAN, unavailable to modify

Current Time: local time of the system

Uptime: operating uptime as long as the system is powered on

Memory

| | | |
|-----------------|---------------------|---|
| Total Available | 28880 kB / 32768 kB |  88% |
| Free | 12436 kB / 28880 kB |  43% |
| Used | 16444 kB / 28880 kB |  57% |
| Buffers | 1660 kB / 16444 kB |  10% |
| Cached | 5708 kB / 16444 kB |  35% |
| Active | 963 kB / 16444 kB |  6% |
| Inactive | 1118 kB / 16444 kB |  7% |

Total Available: the room for total available of RAM (that is physical memory minus some reserve and the kernel of binary code bytes)

Free: free memory, the router will reboot if the memory is less than 500kB

Used: used memory, total available memory minus free memory

Buffers: used memory for buffers,

Cached: the memory used by high-speed cache memory

Active: active use of buffer or cache memory page file size

Inactive: not often used in a buffer or cache memory page file size

Network



IP Filter Maximum Ports: preset is 4096, available to re-management

Active IP Connections: real time monitor active IP connections of the system, click to see the table as blow:

Active IP Connections 53

| No. | Protocol | Timeout (s) | Source Address | Remote Address | Service Name | State |
|-----|----------|-------------|----------------|-----------------|--------------|----------------|
| 1 | TCP | 60 | 192.168.1.120 | 192.168.1.1 | | 80 TIME_WAIT |
| 2 | TCP | 30 | 192.168.1.120 | 192.168.1.1 | | 80 TIME_WAIT |
| 3 | TCP | 65 | 192.168.1.120 | 192.168.1.1 | | 80 TIME_WAIT |
| 4 | TCP | 96 | 192.168.1.120 | 192.168.1.1 | | 80 TIME_WAIT |
| 5 | TCP | 99 | 192.168.1.120 | 192.168.1.1 | | 80 TIME_WAIT |
| 6 | TCP | 70 | 192.168.1.120 | 192.168.1.1 | | 80 TIME_WAIT |
| 7 | TCP | 74 | 192.168.1.120 | 192.168.1.1 | | 80 TIME_WAIT |
| 8 | TCP | 115 | 192.168.1.120 | 192.168.1.1 | | 80 TIME_WAIT |
| 9 | TCP | 84 | 192.168.1.120 | 192.168.1.1 | | 80 TIME_WAIT |
| 10 | TCP | 3599 | 192.168.1.120 | 192.168.1.1 | | 80 ESTABLISHED |
| 11 | TCP | 3599 | 192.168.1.120 | 192.168.1.1 | | 80 ESTABLISHED |
| 12 | TCP | 108 | 192.168.1.120 | 192.168.1.1 | | 80 TIME_WAIT |
| 13 | TCP | 3600 | 192.168.1.120 | 192.168.1.1 | | 80 ESTABLISHED |
| 14 | TCP | 93 | 192.168.1.120 | 192.168.1.1 | | 80 TIME_WAIT |
| 15 | TCP | 102 | 192.168.1.120 | 192.168.1.1 | | 80 TIME_WAIT |
| 16 | TCP | 74 | 192.168.1.120 | 192.168.1.1 | | 80 TIME_WAIT |
| 17 | TCP | 3599 | 192.168.1.120 | 192.168.1.1 | | 80 ESTABLISHED |
| 18 | TCP | 15 | 192.168.1.120 | 192.168.1.1 | | 80 TIME_WAIT |
| 19 | TCP | 25 | 192.168.1.120 | 192.168.1.1 | | 80 TIME_WAIT |
| 20 | TCP | 90 | 192.168.1.120 | 192.168.1.1 | | 80 TIME_WAIT |
| 21 | UDP | 26 | 192.168.8.119 | 255.255.255.255 | 1947 | UNREPLIED |
| 22 | TCP | 77 | 192.168.1.120 | 192.168.1.1 | | 80 TIME_WAIT |
| 23 | TCP | 35 | 192.168.1.120 | 192.168.1.1 | | 80 TIME_WAIT |
| 24 | TCP | 74 | 192.168.1.120 | 192.168.1.1 | | 80 TIME_WAIT |
| 25 | TCP | 40 | 192.168.1.120 | 192.168.1.1 | | 80 TIME_WAIT |
| 26 | TCP | 3599 | 192.168.1.120 | 192.168.1.1 | | 80 ESTABLISHED |
| 27 | TCP | 74 | 192.168.1.120 | 192.168.1.1 | | 80 TIME_WAIT |
| 28 | TCP | 74 | 192.168.1.120 | 192.168.1.1 | | 80 TIME_WAIT |
| 29 | TCP | 4 | 192.168.1.120 | 192.168.1.1 | | 80 TIME_WAIT |
| 30 | UDP | 31 | 192.168.8.160 | 224.0.0.1 | 9166 | UNREPLIED |
| 31 | TCP | 74 | 192.168.1.120 | 192.168.1.1 | | 80 TIME_WAIT |

Active IP Connections: total active IP connections

Protocol: connection protocol

Timeouts: connection timeouts, unit is second

Source Address: source IP address

Remote Address: remote IP address

Service Name: connecting service port

Status: displayed status

3.3.11.2 WAN

Connection Type Automatic Configuration - DHCP

Connection Uptime Not available

Connection Type: disabled, static IP, automatic configuration-DHCP, PPPOE, PPTP, L2TP, 3G/UMTS

Connection Uptime: connecting uptime; If disconnect, display Not available

| | |
|-------------|---------|
| IP Address | 0.0.0.0 |
| Subnet Mask | 0.0.0.0 |
| Gateway | 0.0.0.0 |
| DNS 1 | |
| DNS 2 | |
| DNS 3 | |

IP Address: IP address of router WAN

Subnet Mask: subnet mask of router WAN

Gateway: the gateway of router WAN

DNS1, DNS2, DNS3: DNS1/DNS2/DNS3 of router WAN

Remaining Lease Time 0 days 23:38:43

DHCP Release

DHCP Renew

Remaining Lease Time: remaining lease time of IP address in DHCP way

DHCP Release: release DHCP address

DHCP Renew: renew IP address in DHCP way, default is 1 day

Login Status Disconnected

Login Status: connection status of WAN

Disconnection: disconnect

Connection: connect

Module Type ZTE-EVDO MODULE



Signal Status -79 dBm

Network CDMA/HDR

Module Type: module type in 3G/UMTS way

Signal Status: signal intensity of the module in 3G/UMTS way

Network: network type of the module in 3G/UMTS way

Total Traffic

| | |
|-------------------|---|
| Incoming (MBytes) | 0 |
| Outgoing (MBytes) | 0 |

Traffic by Month

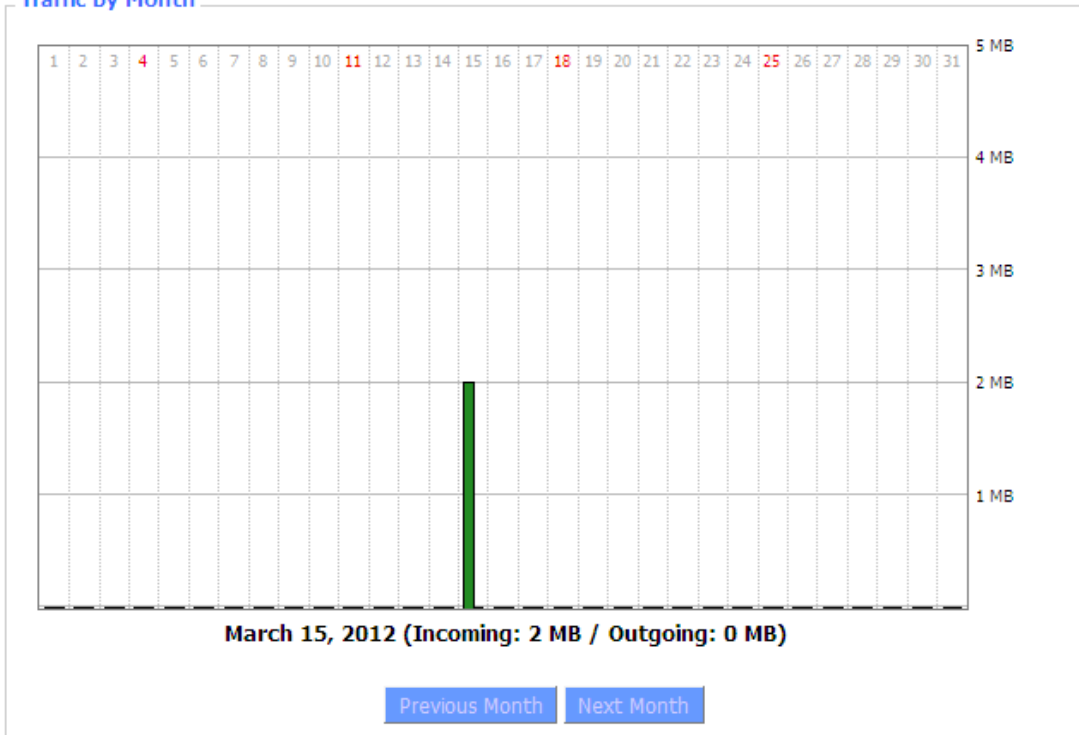

Total Flow: flow from power-off last time until now statistics, download and upload direction

Monthly Flow: the flow of a month, unit is MB

Last Month: the flow of last month

Next Month: the flow of next month

Data Administration

Backup Restore Delete

Backup: backup data administration

Restore: restore data administration

Delete: delete data administration

3.3.11.3 LAN

LAN Status

| | |
|-------------|--------------------------|
| MAC Address | <u>00:0C:43:30:52:77</u> |
| IP Address | 192.168.1.1 |
| Subnet Mask | 255.255.255.0 |
| Gateway | 0.0.0.0 |
| Local DNS | 0.0.0.0 |

MAC Address: MAC Address of the LAN port ethernet

IP Address: IP Address of the LAN port

Subnet Mask: Subnet Mask of the LAN port

Gateway: Gateway of the LAN port

Local DNS: DNS of the LAN port

Active Clients

| Host Name | IP Address | MAC Address | Conn. Count | Ratio [4096] |
|-----------|---------------|--------------------------|-------------|--------------|
| * | 192.168.1.120 | <u>10:78:D2:98:C9:46</u> | 57 | 1% |

Host Name: host name of LAN client

IP Address: IP address of the client

MAC Address: MAC address of the client

Conn. Count: connection count caused by the client

Ratio: the ratio of 4096 connection

Dynamic Host Configuration Protocol

DHCP Status

| | |
|-------------------|---------------|
| DHCP Server | Enabled |
| DHCP Daemon | uDHCpd |
| Start IP Address | 192.168.1.100 |
| End IP Address | 192.168.1.149 |
| Client Lease Time | 1440 minutes |

DHCP Server: enable or disable the router work as a DHCP server



DHCP Daemon: the agreement allocated using DHCP including DNSMasq and uDHCpd

Starting IP Address: the starting IP Address of the DHCP server's Address pool

Ending IP Address: the ending IP Address of the DHCP server's Address pool

Client Lease Time: the lease time of DHCP client

DHCP Clients

| Host Name | IP Address | MAC Address | Client Lease Time | Delete |
|-----------------|---------------|--------------------------|-------------------|---|
| PC-201011161332 | 192.168.1.142 | <u>00:21:5C:33:4D:29</u> | 1 day 00:00:00 |  |
| jack-lincw | 192.168.1.117 | <u>44:37:E6:3F:45:54</u> | 1 day 00:00:00 |  |
| * | 192.168.1.149 | <u>00:0C:E7:00:00:00</u> | 1 day 00:00:00 |  |

Host Name: host name of LAN client

IP Address: IP address of the client

MAC Address: MAC address of the client

Expires: the expiry the client rents the IP address

Delete: click to delete DHCP client

Connected PPPOE Clients

| Interface | User Name | Local IP | Delete |
|-----------|-----------|---------------|---|
| ppp0 | hometest | 192.168.10.10 |  |

Interface: the interface assigned by dial-up system

User Name: user name of PPPoE client

Local IP: IP address assigned by PPPoE client

Delete: click to delete PPPoE client

Connected L2TP Server

| Interface | Local IP | Remote IP | Delete |
|-----------|-------------|-------------|---|
| ppp0 | 172.168.8.2 | 172.168.8.1 |  |

Interface: the interface assigned by dial-up system

Local IP: tunnel IP address of local L2TP

Remote IP: tunnel IP address of L2TP server

Delete: click to disconnect L2TP

Connected L2TP Clients

| Interface | User Name | Local IP | Remote IP | Delete |
|-----------|-----------|--------------|--------------|---|
| ppp1 | hometest | 192.168.50.2 | 120.42.46.98 |  |

Interface: the interface assigned by dial-up system

User Name: user name of the client

Local IP: tunnel IP address of L2TP client

Remote IP: IP address of L2TP client

Delete: click to delete L2TP client

Connected PPTP Server

| Interface | Local IP | Remote IP | Delete |
|-----------|-------------|-------------|---|
| ppp0 | 172.168.8.2 | 172.168.8.1 |  |

Interface: the interface assigned by dial-up system

Local IP: tunnel IP address of local PPTP

Remote IP: tunnel IP address of PPTP server

Delete: click to disconnect PPTP

Connected PPTP Clients

| Interface | User Name | Local IP | Remote IP | Delete |
|-----------|-----------|-------------|--------------|---|
| ppp1 | hometest | 192.168.5.1 | 120.42.46.98 |  |

Interface: the interface assigned by dial-up system

User Name: user name of the client

Local IP: tunnel IP address of PPTP client

Remote IP: IP address of PPTP client

Delete: click to delete PPTP client

3.3.11.4 Wireless

Wireless Status

| | |
|----------------------------|--------------------------|
| MAC Address | <u>00:0C:43:30:52:79</u> |
| Radio | Radio is On |
| Mode | AP |
| Network | Mixed |
| SSID | four-faith |
| Channel | 6 (2437 MHz) |
| TX Power | 71 mW |
| Rate | 72 Mb/s |
| Encryption - Interface w10 | Disabled |
| PPTP Status | Disconnected |

MAC Address: MAC address of wireless client

Radio: display whether radio is on or not

Mode: wireless mode

Network: wireless network mode

SSID: wireless network name

Channel: wireless network channel

TX Power: reflection power of wireless network

Rate: reflection rate of wireless network

Encryption-Interface w10: enable or diasbal Encryption-Interface w10

PPTP Status: show wireless pptp status

Wireless Packet Info

| | | |
|------------------|--------------------|--|
| Received (RX) | 91125 OK, no error | <div style="width: 100%; height: 10px; background-color: #4F81BD;"></div> 100% |
| Transmitted (TX) | 11957 OK, no error | <div style="width: 100%; height: 10px; background-color: #4F81BD;"></div> 100% |

Received (RX): received data packet

Transmitted (TX): transmitted data packet

| Wireless Nodes | | | | | | | | |
|----------------|-----------|--------|---------|---------|--------|-------|-----|----------------|
| Clients | | | | | | | | |
| MAC Address | Interface | Uptime | TX Rate | RX Rate | Signal | Noise | SNR | Signal Quality |
| - None - | | | | | | | | |

MAC Address: MAC address of wireless client

Interface: interface of wireless client

Uptime: connecting uptime of wireless client

TX Rate: transmit rate of wireless client

RX Rate: receive rate of wireless client

Signal: the signal of wireless client

Noise: the noise of wireless client

SNR: the signal to noise ratio of wireless client

Signal Quality: signal quality of wireless client

| Neighbor's Wireless Networks | | | | | | | | | | |
|------------------------------|---------|-----------------------------------|---------|------|-------|--------|------|------|------------|----------------------|
| SSID | Mode | MAC Address | Channel | Rssi | Noise | beacon | Open | dtim | Rate | Join Site |
| tzt-3g | Unknown | 00:aa:bb:cc:dd:14 | 2 | -5 | -95 | 0 | No | 0 | 54(b/g) | Join |
| four-faith | Unknown | 00:0c:43:30:52:79 | 6 | -24 | -95 | 0 | No | 0 | 300(b/g/n) | Join |
| ff-old | AP | 00:13:10:09:56:92 | 6 | -55 | -95 | 0 | No | 0 | 54(b/g) | Join |

Neighbor's Wireless Network: display other networks nearby

SSID: the name of wireless network nearby

Mode: operating mode of wireless network nearby

MAC Address: MAC address of the wireless nearby

Channel: the channel of the wireless nearby

Rssi: signal intensity of the wireless nearby

Noise: the noise of the wireless nearby

Beacon: signal beacon of the wireless nearby

Open: the wireless nearby is open or not

Dtim: delivery traffic indication message of the wireless nearby

Rate: speed rate of the wireless nearby

Join Site: click to join wireless network nearby

3.3.11.5 Bandwidth

Bandwidth Monitoring - LAN

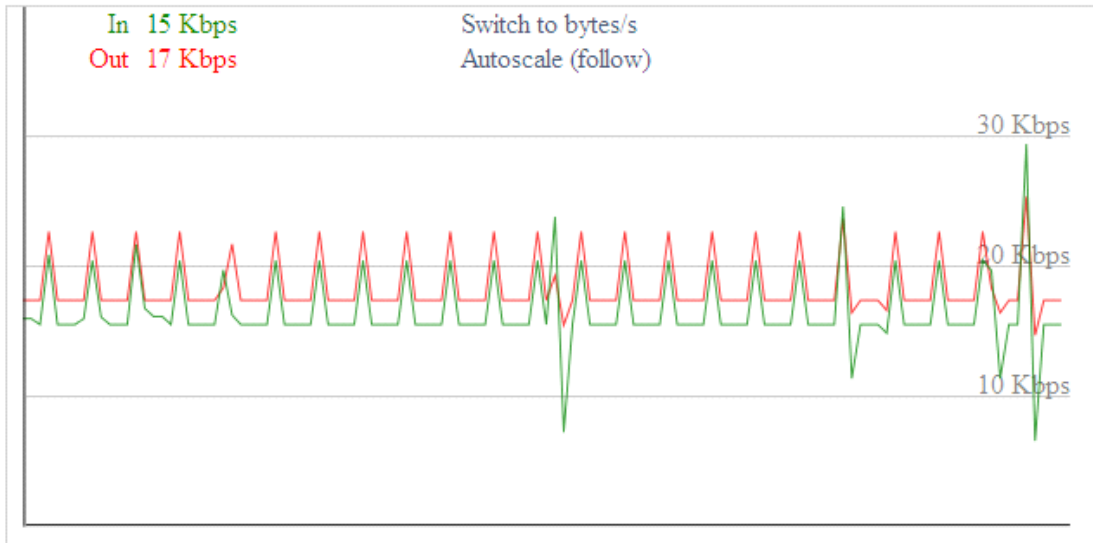

Bandwidth Monitoring-LAN Graph

abscissa axis: time

vertical axis: speed rate

Bandwidth Monitoring - WAN

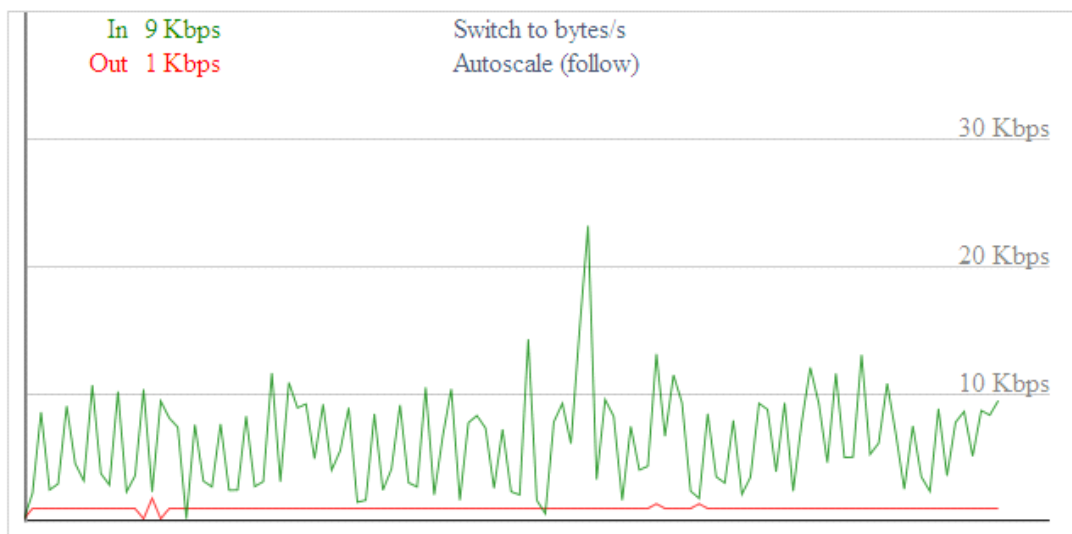

Bandwidth Monitoring-WAN Graph

abscissa axis: time

vertical axis: speed rate

Bandwidth Monitoring - Wireless (w10)

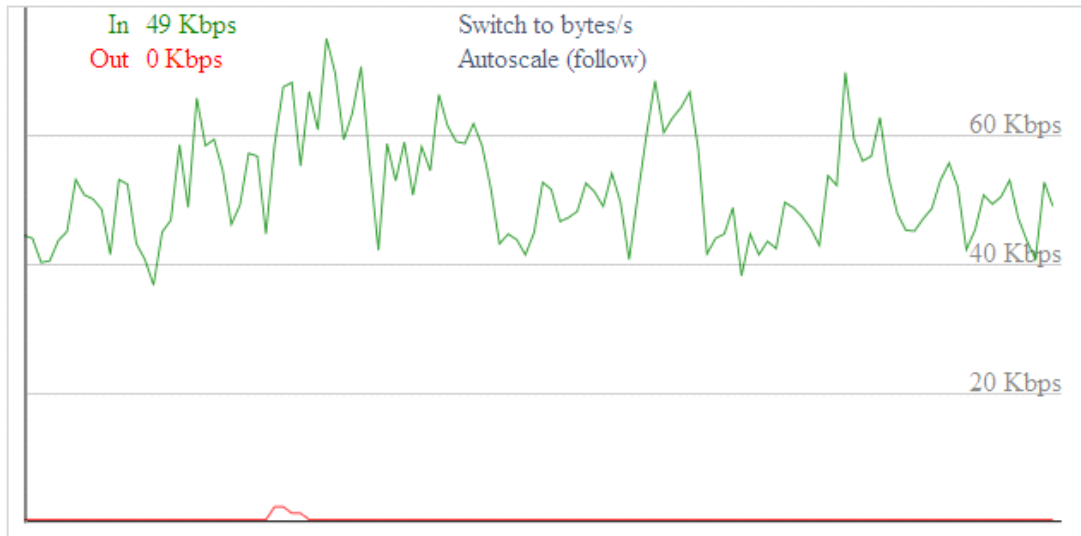

Bandwidth Monitoring-Wireless (W10) Graph

abscissa axis: time

vertical axis: speed rate

3.3.11.6 Sys-Info

Router

| | |
|--------------|--------------------------|
| Router Name | Four-Faith |
| Router Model | Four-Faith Router |
| LAN MAC | <u>00:0C:43:30:52:77</u> |
| WAN MAC | <u>00:0C:43:30:52:78</u> |
| Wireless MAC | <u>00:0C:43:30:52:79</u> |
| WAN IP | 10.34.107.156 |
| LAN IP | 192.168.1.1 |

Router Name: the name of the router

Router Model: the model of the router

LAN MAC: MAC address of LAN port

WAN MAC: MAC address of WAN port

Wireless MAC: MAC address of the wireless

WAN IP: IP address of WAN port

LAN IP: IP address of LAN port

Wireless

| | |
|----------|--------------|
| Radio | Radio is On |
| Mode | AP |
| Network | Mixed |
| SSID | four-faith |
| Channel | 6 (2437 MHz) |
| TX Power | 71 mW |
| Rate | 72 Mb/s |

Radio: display whether radio is on or not

Mode: wireless mode

Network: wireless network mode

SSID: wireless network name

Channel: wireless network channel

TX Power: reflection power of wireless network

Rate: reflection rate of wireless network

Wireless Packet Info

| | |
|------------------|-------------------|
| Received (RX) | 6982 OK, no error |
| Transmitted (TX) | 1498 OK, no error |

Received (RX): received data packet

Transmitted (TX): transmitted data packet

Wireless

Clients

| MAC Address | Interface | Uptime | TX Rate | RX Rate | Signal | Noise | SNR | Signal Quality |
|-------------|-----------|--------|---------|---------|--------|-------|-----|----------------|
| - None - | | | | | | | | |

MAC Address: MAC address of wireless client

Interface: interface of wireless client

Uptime: connecting uptime of wireless client

TX Rate: transmit rate of wireless client

RX Rate: receive rate of wireless client

Signal: the signal of wireless client

Noise: the noise of wireless client

SNR: the signal to noise ratio of wireless client

Signal Quality: signal quality of wireless client

Services

| | |
|-------------|----------|
| DHCP Server | Enabled |
| ff-radauth | Disabled |
| USB Support | Disabled |

DHCP Server: enabled or disabled

ff-radauth: enabled or disabled

USB Support: enabled or disabled

Memory

| | |
|-----------------|-------------------|
| Total Available | 28.2 MB / 32.0 MB |
| Free | 11.2 MB / 28.2 MB |
| Used | 17.0 MB / 28.2 MB |
| Buffers | 1.8 MB / 17.0 MB |
| Cached | 6.3 MB / 17.0 MB |
| Active | 1.5 MB / 17.0 MB |
| Inactive | 0.8 MB / 17.0 MB |

Total Available: the room for total available of RAM (that is physical memory minus some reserve and the kernel of binary code bytes)

Free: free memory, the router will reboot if the memory is less than 500kB

Used: used memory, total available memory minus free memory

Buffers: used memory for buffers, total available memory minus allocated memory

Cached: the memory used by high-speed cache memory

Active: Active use of buffer or cache memory page file size

Inactive: Not often used in a buffer or cache memory page file size

DHCP

DHCP Clients

| Host Name | IP Address | MAC Address | Expires |
|-----------------|---------------|-------------------|----------------|
| * | 192.168.1.143 | xx:xx:xx:xx:DD:45 | 1 day 00:00:00 |
| four-488e1df5fa | 192.168.1.125 | xx:xx:xx:xx:D8:F7 | 1 day 00:00:00 |
| Mycenae-PC | 192.168.1.116 | xx:xx:xx:xx:5E:30 | 1 day 00:00:00 |

Host Name: host name of LAN client

IP Address: IP address of the client

MAC Address: MAC address of he client

Expires: the expiry the client rents the IP address

Chapter 4 Appendix

The following steps describe how to setup Windows XP Hyper Terminal.

1. Press “Start”→”Programs”→”Accessories”→”Communications”→”Hyper Terminal”



2. Input connection name, choose “OK”
3. Choose the correct COM port which connects to modem, choose “OK”



4. Configure the serial port parameters as following, choose “OK”

Bits per second: 115200

Xiamen Four-Faith Communication Technology Co.,Ltd.

Page 89 of 90

Add: J1-J3,3rdFloor,No.44,GuanRiRoad,SoftWare Park,XiaMen .361008.China

http: //www.fourfaith.com Tel: +86 592-6300326 6300325 6300324 Fax: +86 592-5912735

Data bits: 8
Parity: None
Stop bits: 1
Flow control: None

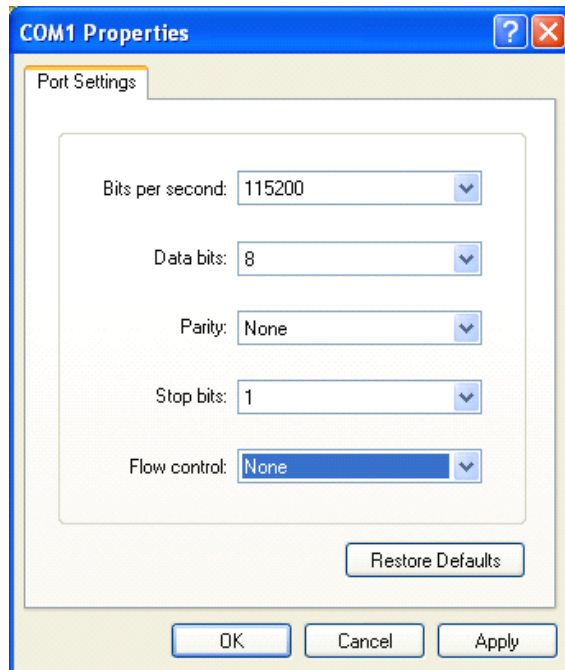

5. Complete Hyper Terminal operation, It runs as following

