



TOYOTA

ALWAYS A
BETTER WAY

Yaris

Front bumper garnish

Installation Instructions

Model year: As from 2020/06
Vehicle code: **P*11-BH***W
Part number: PW401-0D002-**

Manual reference number: AIM 004 583-0

Revision record

Rev. No.	Date	Page	Step	Remarks

PW401-0D002-**

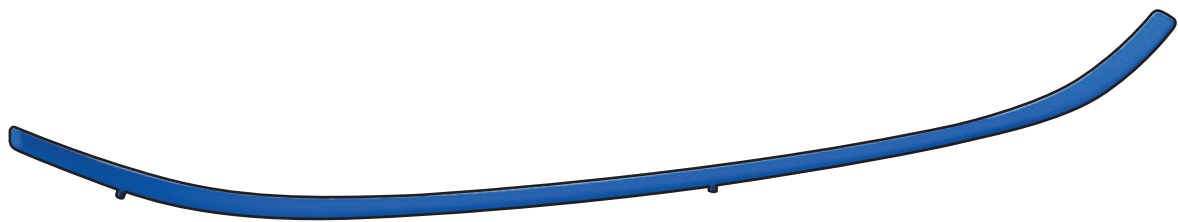

A

x1



x3

Adhesion Promoter

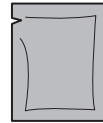

C

x1

= XX mm	=	=
= XX mm	=	=
=	=	=
= TXX	=	= START

	DEGREASER CLEANER AIM 003-516-*		+ °C	? °C	
	Ø 3,5 mm Ø 5 mm Ø 9 mm		10mm	10mm Click	

INFO



Material Safety Data Sheet



Technical Data Sheet

20°C - 40°C

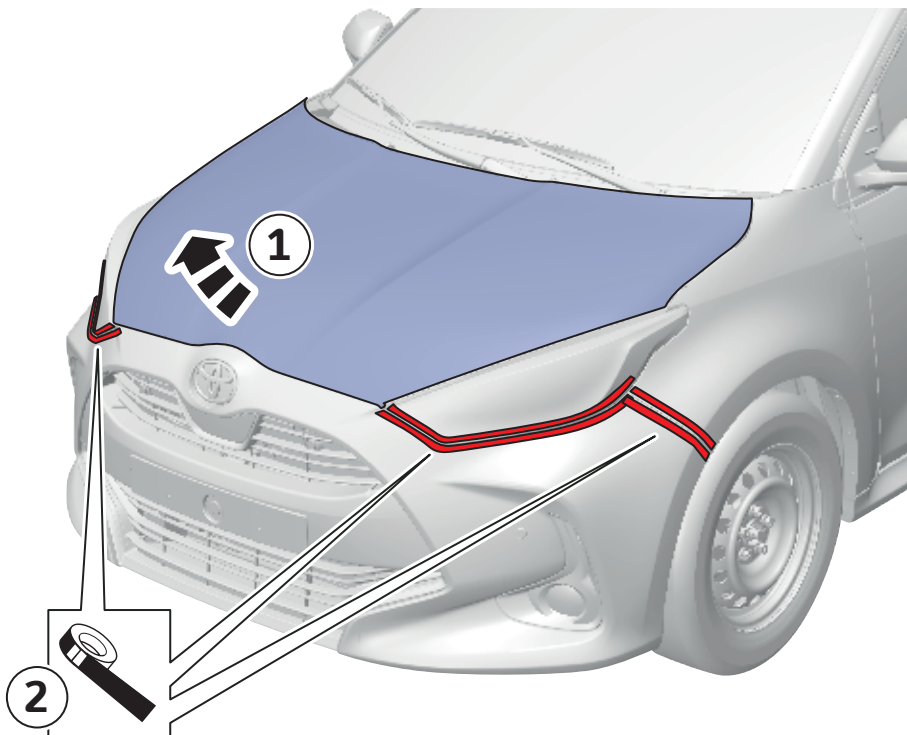
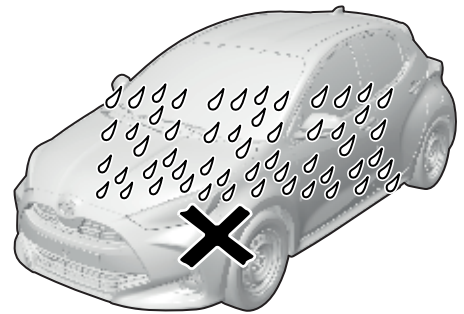
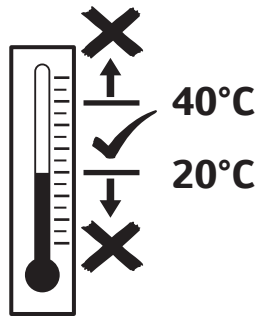
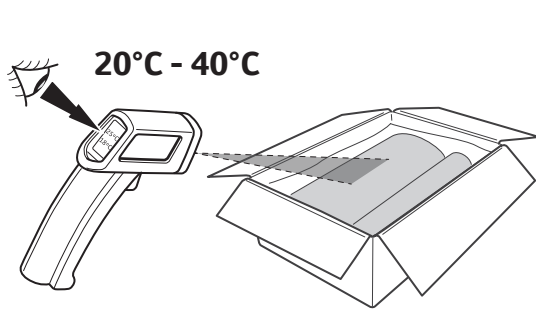
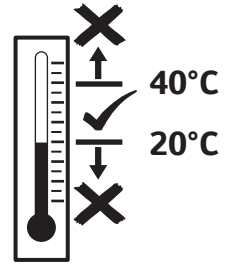
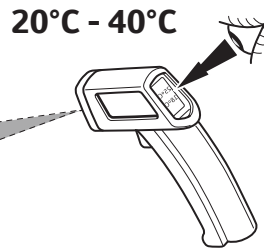
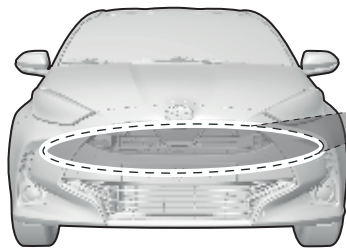

1

CONV

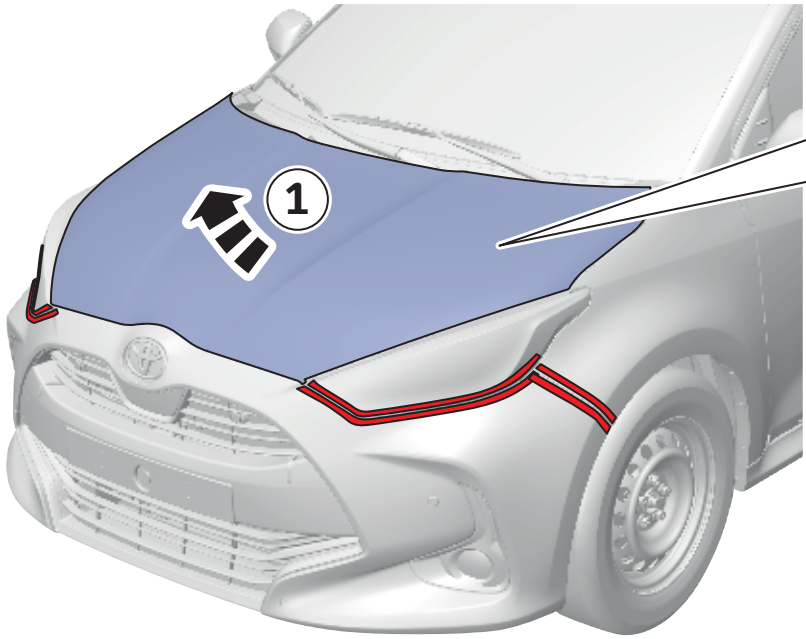

2 1x
10mm

HV

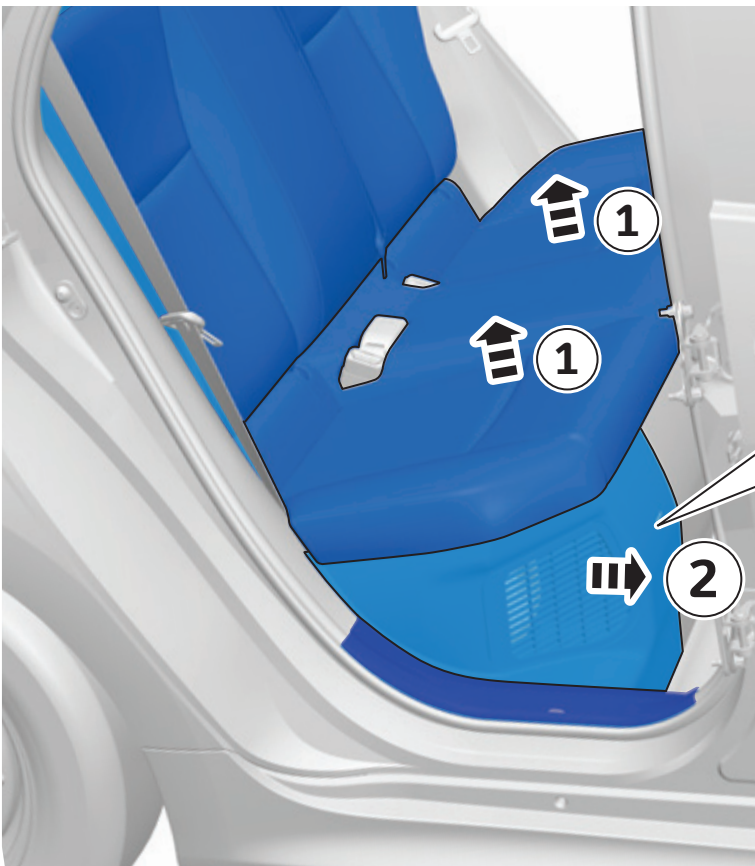

= 4x

= 3x

= 2x

3 1x
10mm

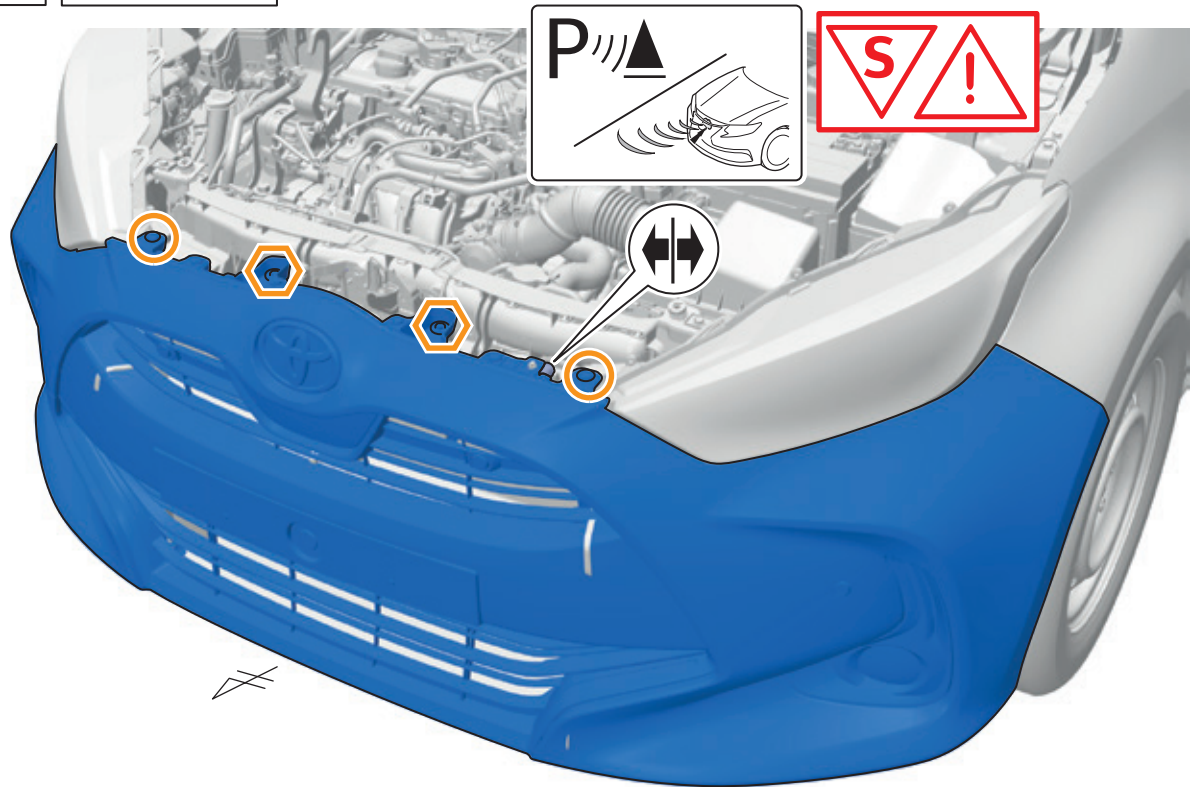
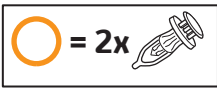
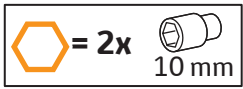

3

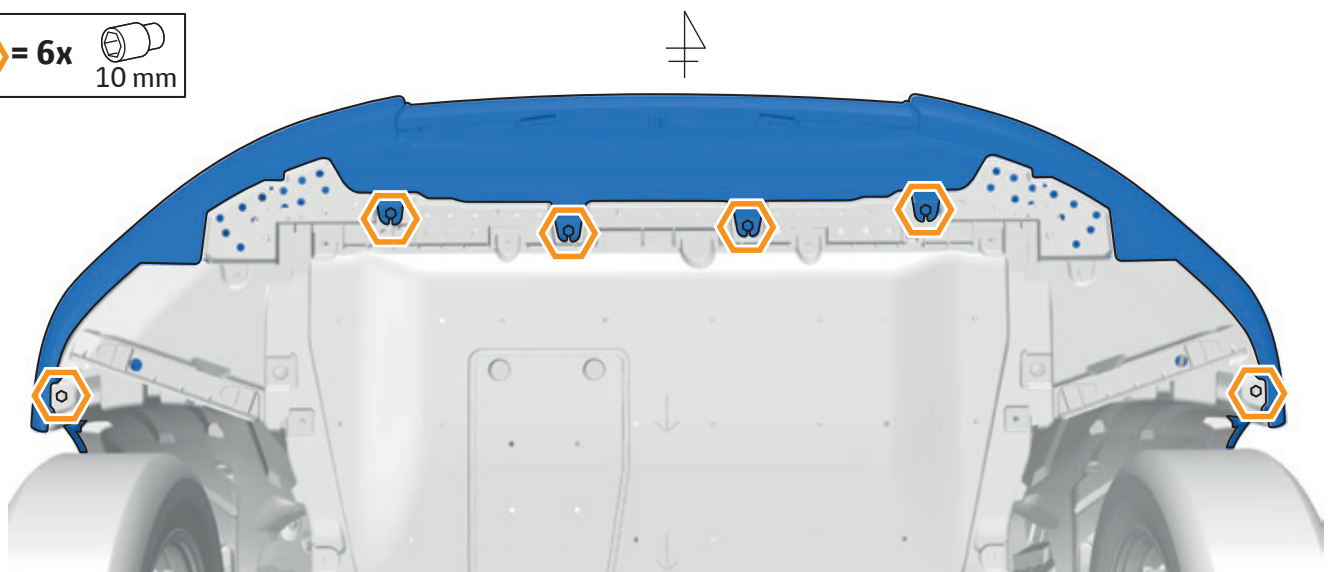
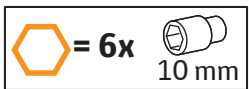

4

1

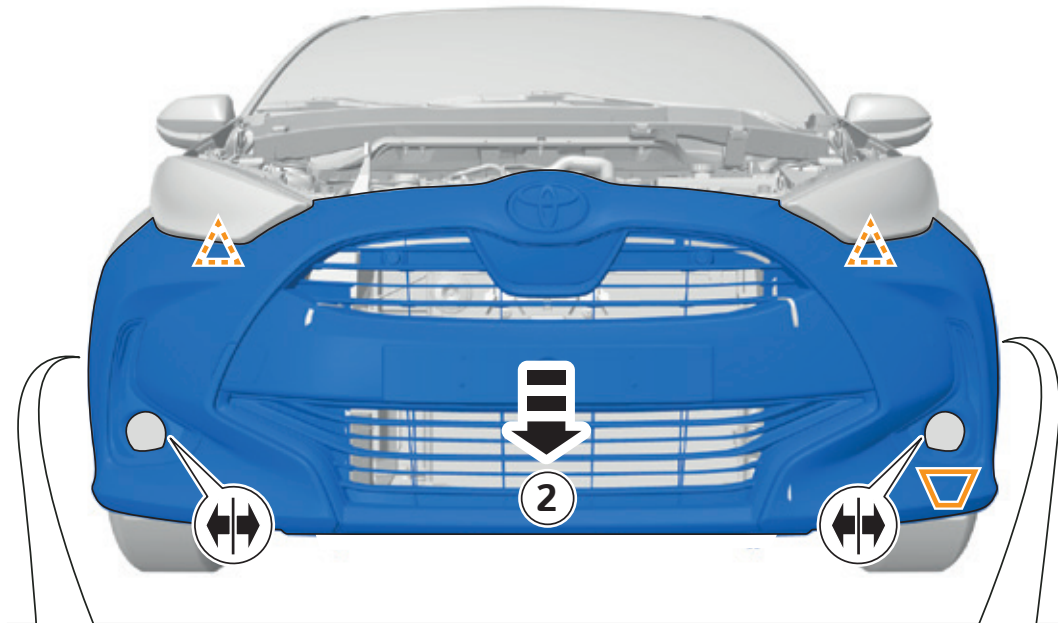
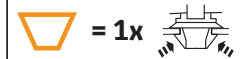
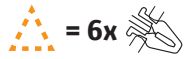

LHS=RHS

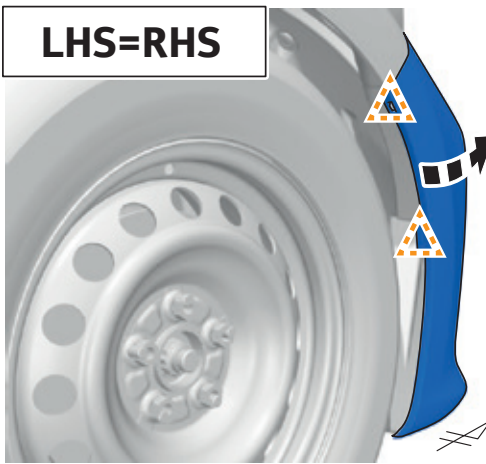

5

1

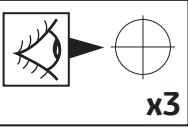

x3

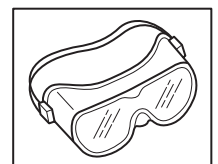
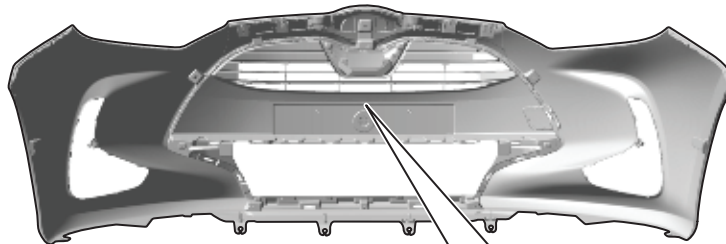

2

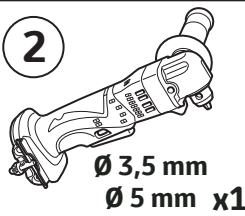

3



2

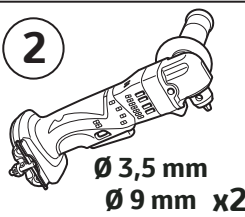

3

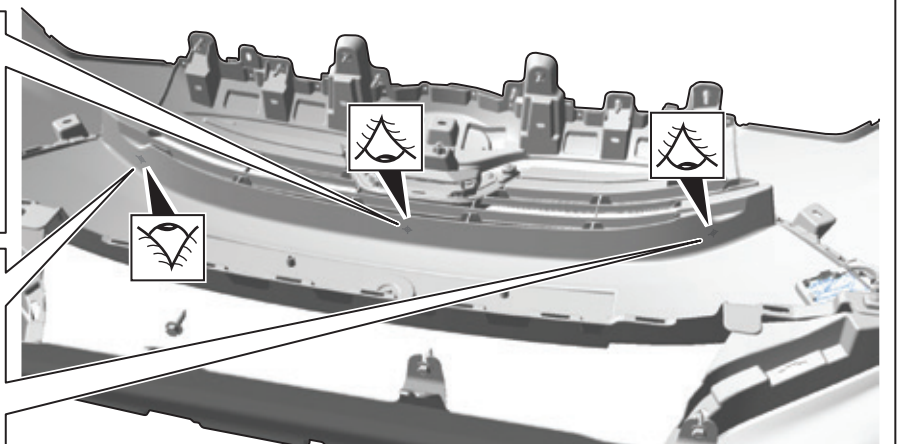

6

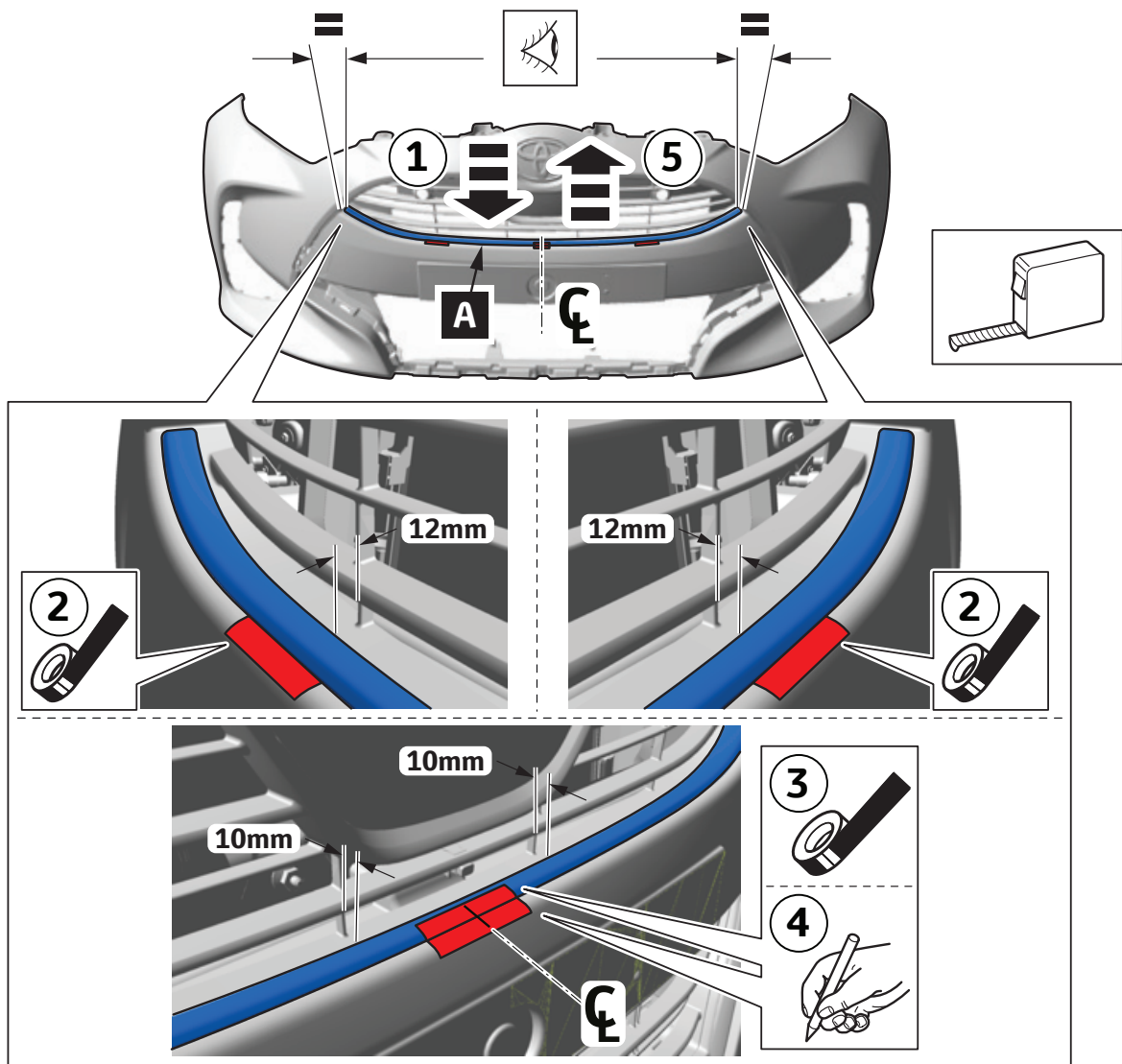

7

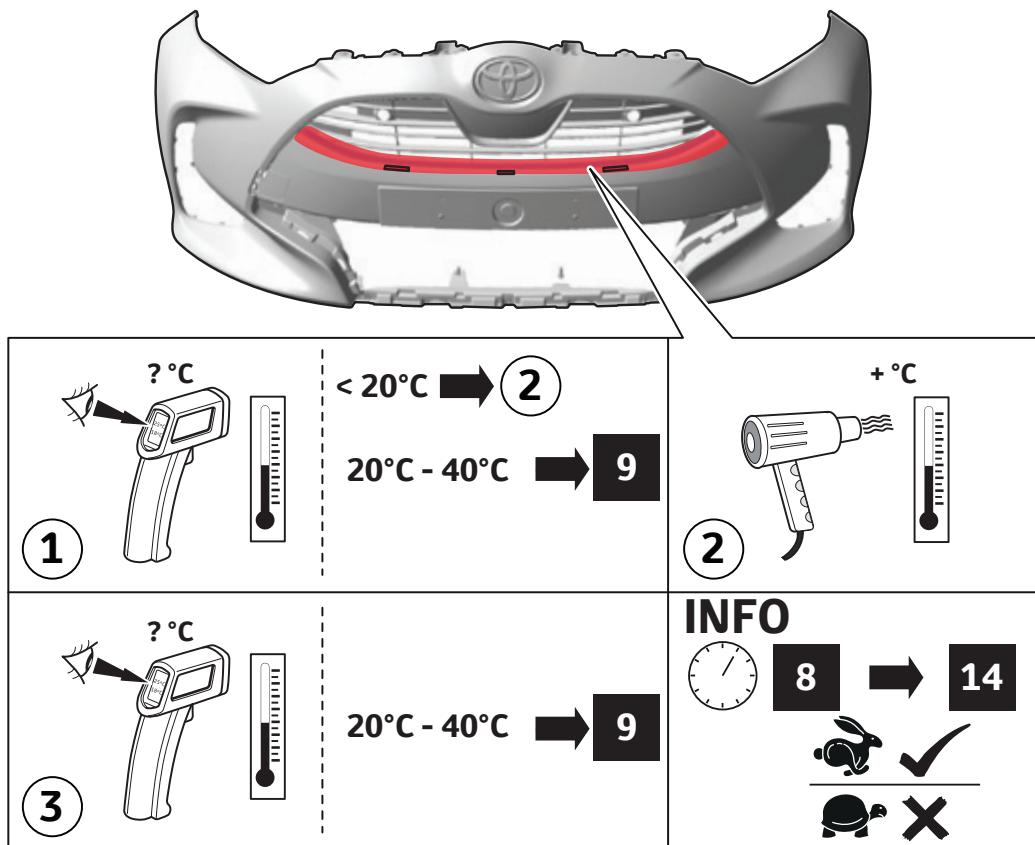

8

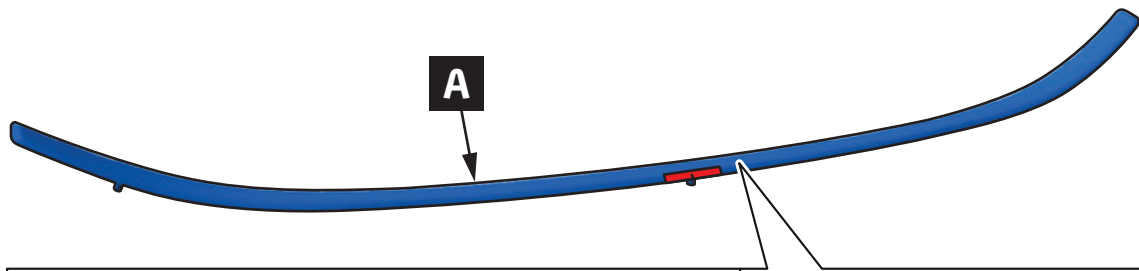

<p>1</p>	<p>< 20°C → 2</p> <p>20°C - 40°C → 10</p>	<p>2</p>
<p>3</p>	<p>20°C - 40°C → 10</p>	<p>INFO</p> <p>9 → 14</p>

9

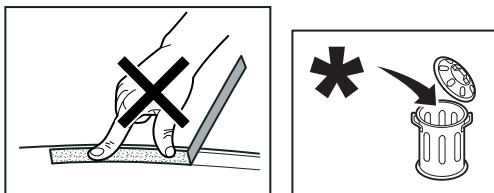
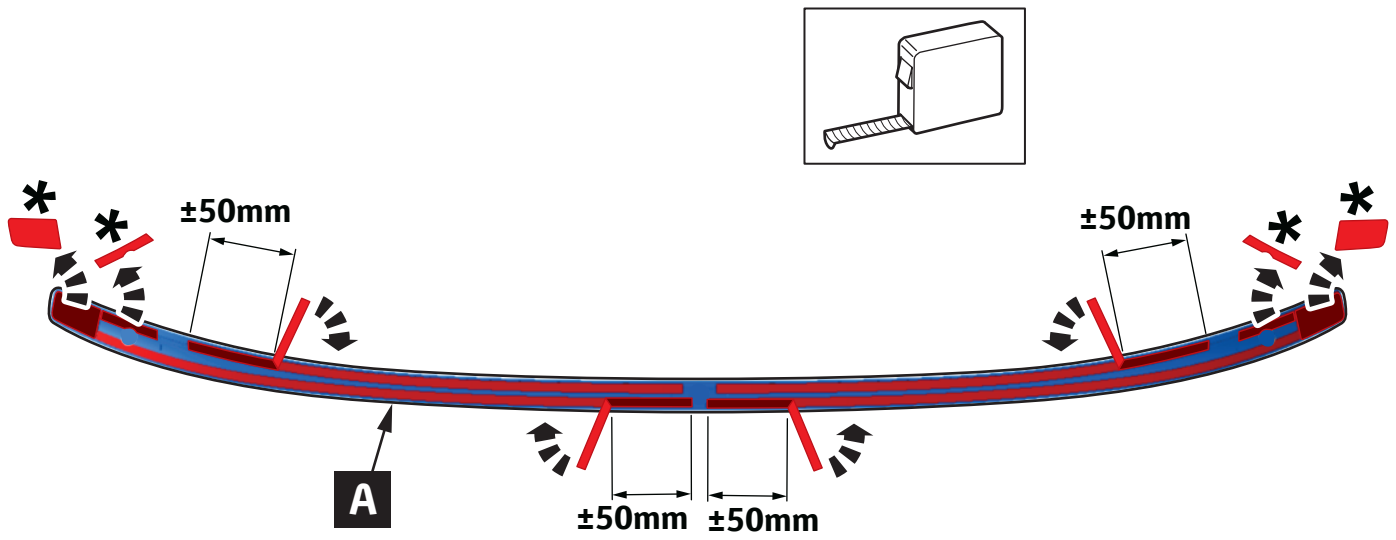

10

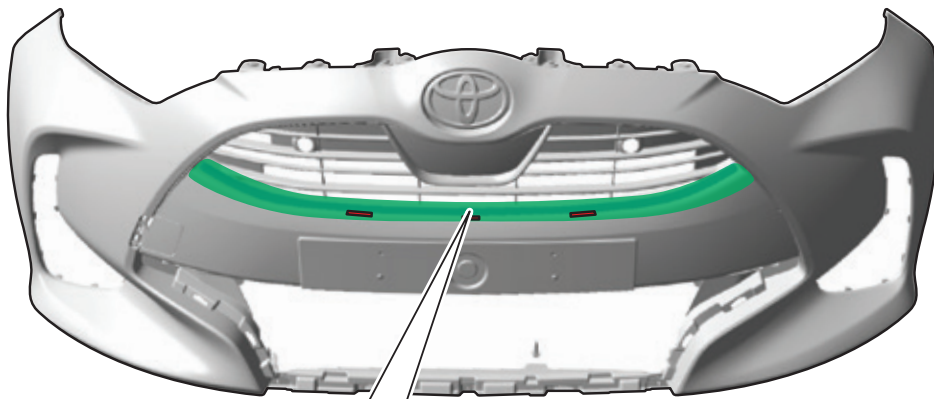

<p>①</p> <p>CLEANER / DEGREASER</p>	<p>②</p>	<p>③</p> <p>C</p> <p>Adhesion Promoter</p>	<p>④</p> <p>→ 14</p> <p>≥ 45 sec. < 1 hour</p>
---	----------	---	--

11

①

①

A

B

②

②

②

B

A

x3

12

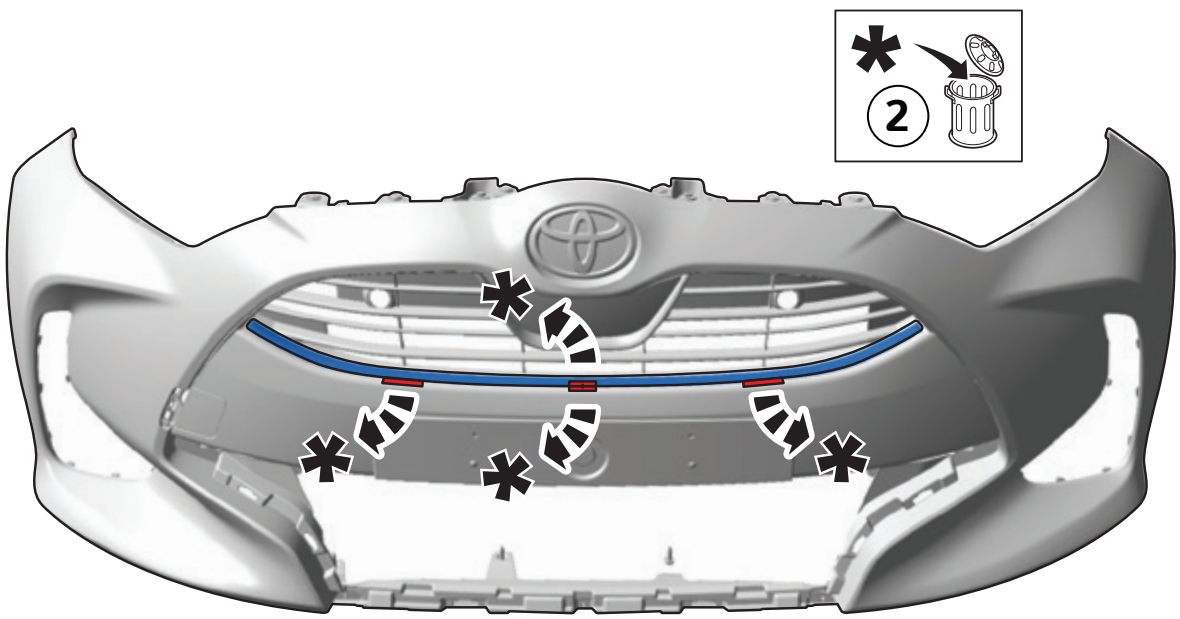
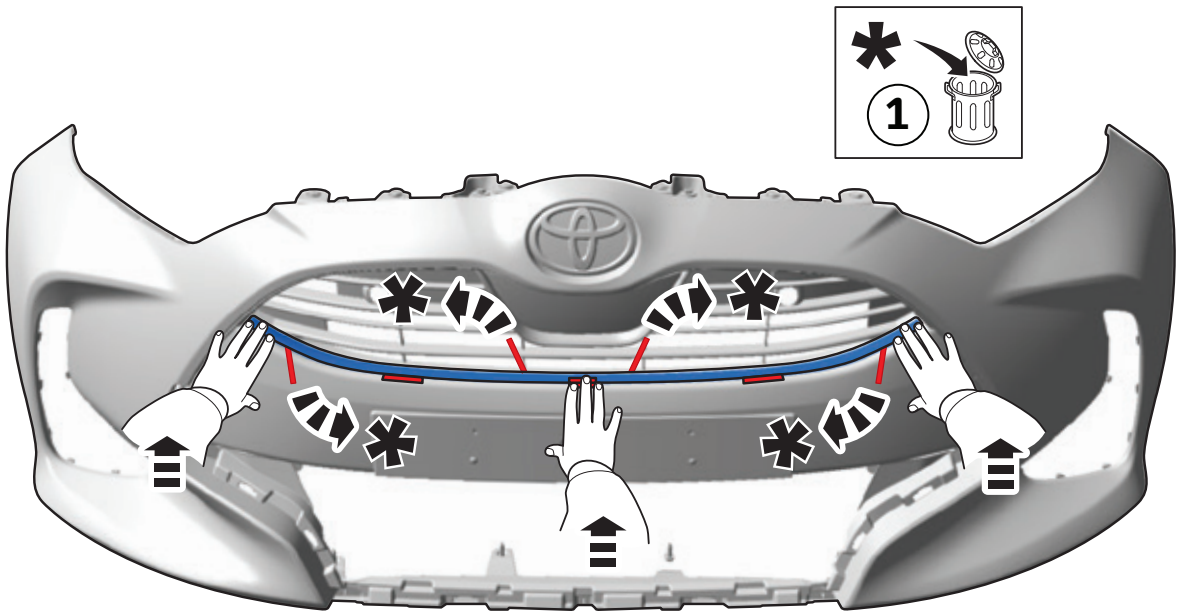

13

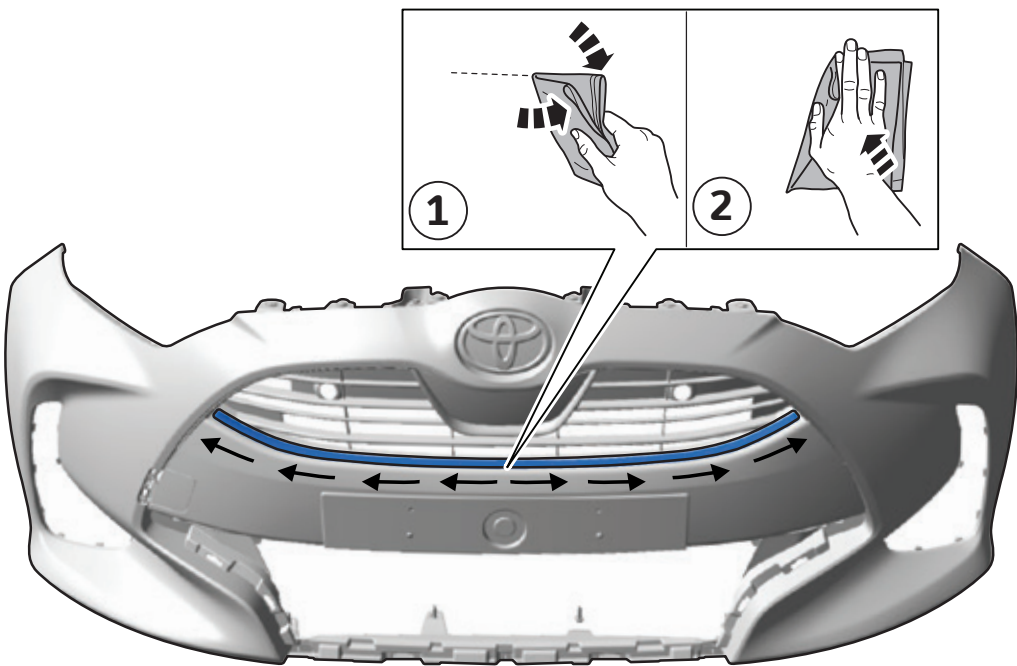

14

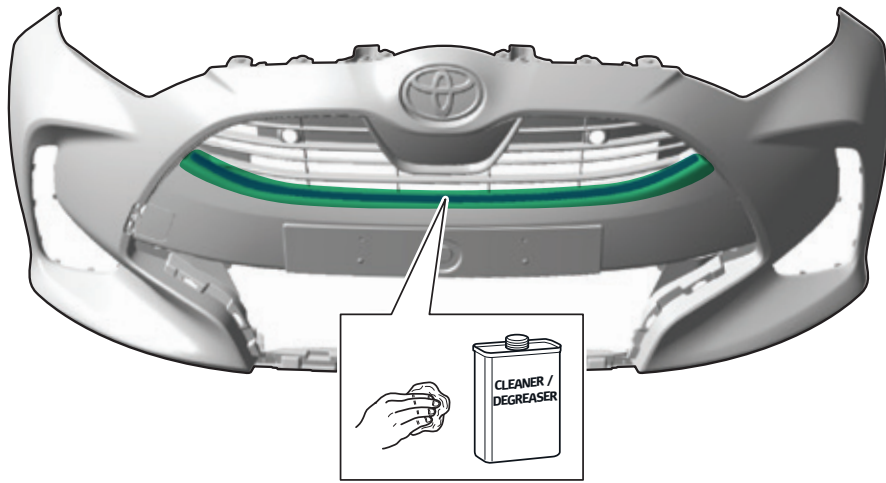

15

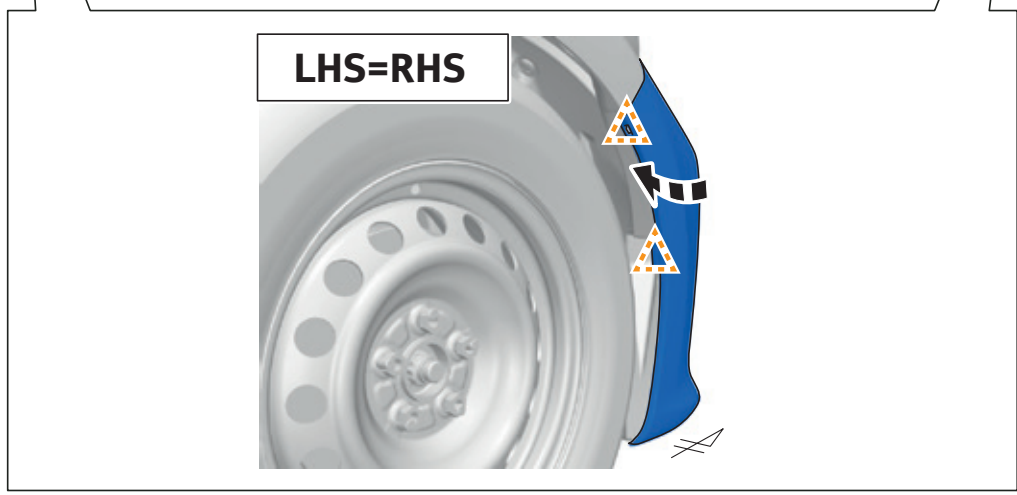
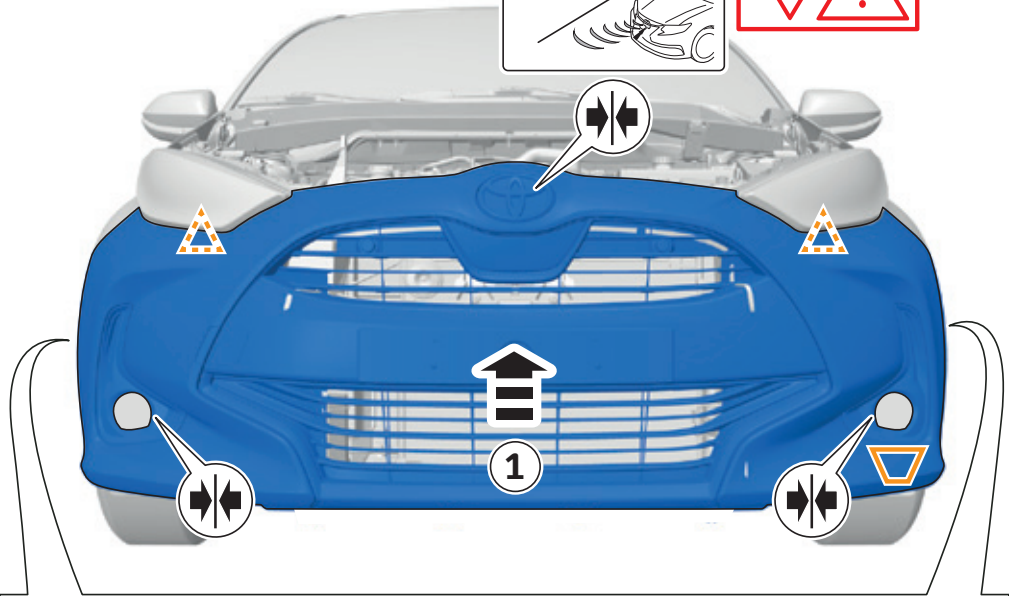
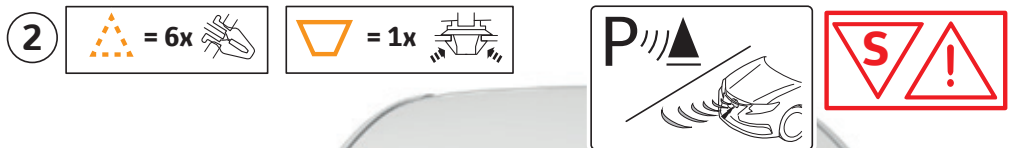

16

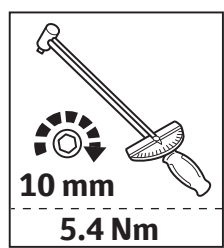
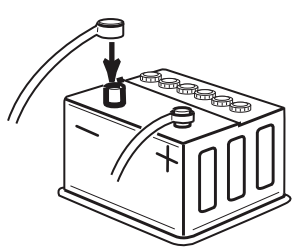

17

INFO

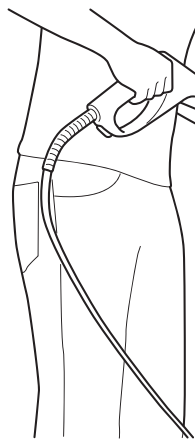
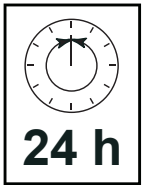
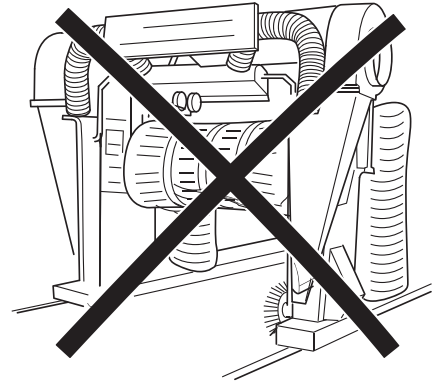
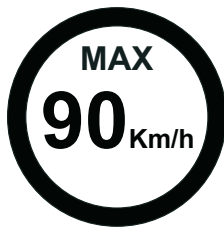
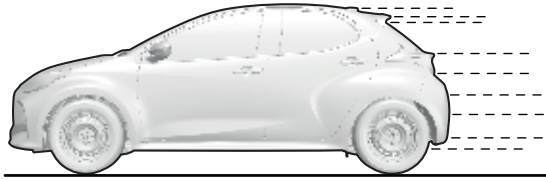
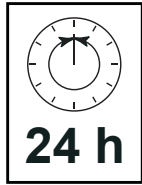
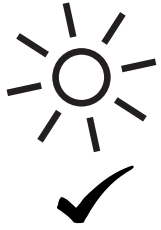

**Minimum
0.5m.**





TOYOTA

CHECK SHEET

Page 1 of 2

Yaris

Model/Year

As from 2020/06

Front bumper garnish

VIN n°

--	--	--	--	--	--	--	--	--	--	--	--	--	--	--	--	--

ALWAYS A BETTER WAY

DURING INSTALLATION

1

P/N = OK

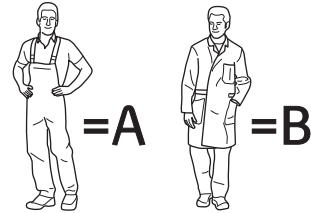

2

3

5,4 Nm

Click

Serial Number

--	--



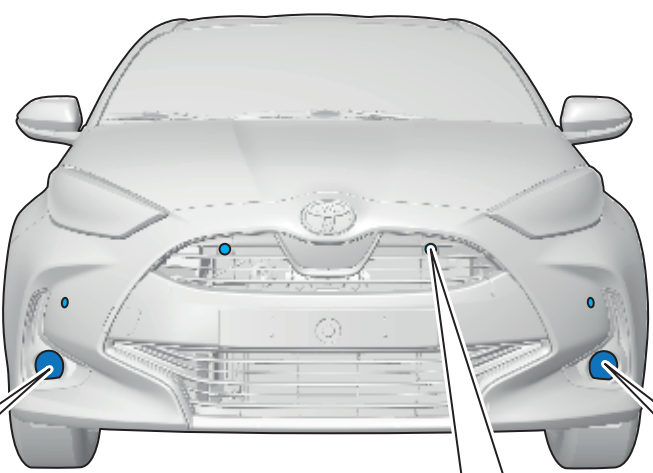

1

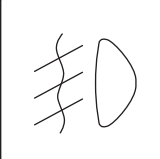





= OK

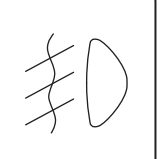

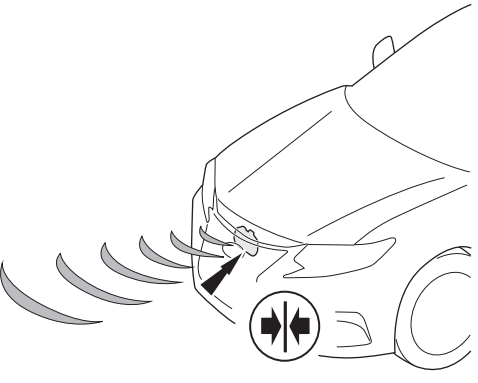
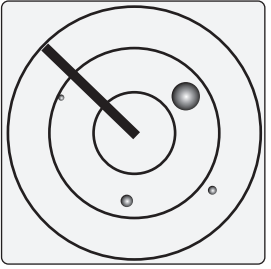



2



= OK

A **B**

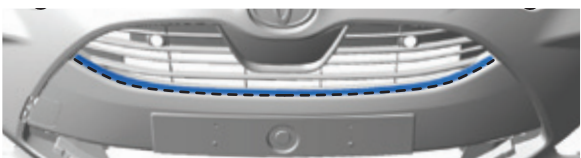

3

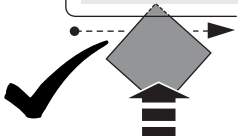

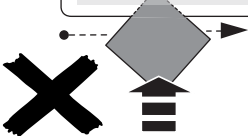

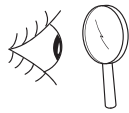

= OK

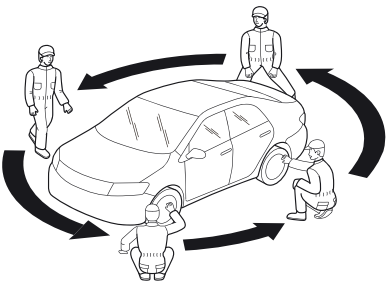

4

Installation Date:

... / ... / ...

Technician Name & Signature:

Stamp: